



RWF55.5 and RWF55.6

Compact universal controllers

Optimized for temperature and pressure control in connection with modulating or multistage burners and air conditioning systems

User Manual

The RWF55.5/RWF55.6 and this User Manual are intended for use by OEMs which integrate the controllers in their products!



Caution!

All safety, warning and technical notes contained in the Data Sheet on the RWF55 (N7867) also apply to this document!

Supplementary documentation

Data Sheet RWF55	N7867
Environmental Declaration RWF55	E7867

Contents

1	Introduction.....	8
1.1	General notes.....	8
1.2	Typographical conventions.....	9
1.2.1	Safety notes.....	9
1.2.2	Warning symbols.....	9
1.2.3	Notification symbols.....	10
1.2.4	Presentation.....	10
1.3	Description.....	11
1.4	Block structure.....	12
2	Identification of product no.	13
2.1	Type field.....	13
2.2	Scope of delivery.....	13
3	Installation.....	14
3.1	Installation site and climatic conditions.....	14
3.2	Dimensions.....	14
3.3	Side-by-side mounting.....	15
3.4	Mounting the controller in a panel cutout.....	15
3.5	Removing the controller from the panel cutout.....	16
3.6	Cleaning the front.....	16
4	Electrical connections.....	17
4.1	Installation notes.....	17
4.2	Galvanic separation.....	18
4.3	Assignment of terminals.....	19
5	Operating modes.....	22
5.1	Low-fire operation.....	22
5.2	High-fire operation.....	23
5.2.1	Modulating burner, 3-position output.....	23
5.2.2	Modulating burner, analog output.....	24
5.2.3	2-stage burner, 3-position output.....	25
5.2.4	2-stage burner, analog output.....	26
5.3	Burner shutdown.....	27
5.4	Predefined setpoint.....	28
5.4.1	Setpoint changeover SP1 / SP2 or setpoint shift analog via InP2.....	29
5.4.2	Setpoint changeover SP1 / external setpoint via InP2.....	30
5.4.3	Setpoint shifting SP1 analog via InP2 / binary via dSP.....	31
5.4.4	External setpoint, setpoint shifting binary via dSP.....	32
5.5	Weather-compensated setpoint shifting.....	33

5.6	Response threshold (q).....	34
5.7	Cold start of plant.....	35
5.8	Thermal shock protection (TSS).....	37
6	Operation.....	38
6.1	Meaning of display and buttons.....	38
6.2	Basic display.....	40
6.3	User level.....	41
6.4	Manual control, modulating burner.....	42
6.5	Manual control, 2-stage burner.....	43
6.6	Starting the self-setting function.....	44
6.7	Display of software version.....	45
7	Parameterization PArA.....	46
8	Configuration ConF.....	49
8.1	Analog input InP1.....	50
8.2	Analog input InP2.....	52
8.3	Analog input InP3.....	53
8.4	Controller Cntr.....	54
8.5	Thermal shock protection (TSS) rAFC.....	55
8.6	Alarm function AF.....	56
8.7	Control outputs OutP.....	58
8.8	Binary input bi nF.....	59
8.9	Display di SP.....	60
8.10	Interface IntF.....	61
9	Self-setting function.....	62
9.1	Self-setting function in high-fire operation.....	62
9.2	Checking the controller parameters.....	64
10	PC software ACS411.....	65
10.1	Safety notes.....	65
10.2	Setting the correct system parameters.....	65
10.3	Changing the parameters or the plant's configuration.....	65
10.4	Place of installation.....	66
10.5	License and liability regulations.....	66
	IMPORTANT – PLEASE READ CAREFULLY!.....	66
10.6	Procurement of PC software ACS411.....	66
10.7	Languages.....	66
10.8	Operating systems : Operating.....	66
10.9	Prerequisites for hardware.....	66
10.10	Installation.....	67
10.11	Others.....	67

10.11.1	Use of USB port : Use of	67
10.11.2	Powering the controller via the USB port : Powering the controller via the port	67
11	Modbus interface	68
11.1	User level.....	68
11.2	Parameter level	69
11.3	Configuration level.....	70
11.4	Remote operation	70
11.5	Device data.....	71
11.6	Device state	71
12	Profibus-DP interface	72
12.1	RS-485 Technology transfer.....	72
12.2	Wiring	77
12.3	Parameter list	77
13	What to do if	78
13.1	Alarm messages:.....	78
13.2	Others.....	78
14	Technical data	79
14.1	Inputs.....	79
14.1.1	Analog input InP1 (actual value).....	79
14.1.2	Analog input InP2 (external setpoint, setpoint shifting).....	81
14.1.3	Analog input InP3 (outside temperature)	81
14.1.4	Binary input D1	81
14.1.5	Binary input D2	82
14.2	Monitoring the measuring circuit.....	83
14.3	Controller outputs OutP	84
14.4	Controller	85
14.5	Electrical data	85
14.6	Housing	85
14.7	Environmental conditions	86
14.8	Segment display	86
14.9	Standards and certificates	87
15	Key	88
16	List of figures	90

1 Introduction

1.1 General notes



Please read this User Manual before switching on the controller. Keep the User Manual in a safe place which can be accessed by all users at all times.



Version!

This User Manual describes all necessary settings (applicable to controller software version XXX.01.01).



Reference!

See chapter 6.7 *Display of software version*.

1.2 Typographical conventions

1.2.1 Safety notes

This User Manual contains information which must be observed to ensure your own personal safety and to prevent damage to equipment and property. The instructions and notes are highlighted by warning triangles, a hand or arrow symbol and are presented as follows, depending on the hazard level:

Qualified personnel

Only **qualified personnel** are allowed to install and operate the equipment. Qualified personnel in the context of the safety-related notes contained in this document are persons who are authorized to commission, ground and tag devices, systems and electrical circuits in compliance with established safety practices and standards.

Correct use

Note the following:

The controller may only be used on the applications described in the technical documentation and only in connection with devices or components from other suppliers that have been approved or recommended by Siemens.

The product can only function correctly and safely if shipped, stored, set up and installed correctly, and operated and maintained as specified.

1.2.2 Warning symbols

The symbols for **Caution** and **Attention** are used in this User Manual under the following conditions:



Caution

This symbol is used where there may be a **danger to personnel** if the instructions are disregarded or not strictly observed!



Attention



This symbol is used where **damage to equipment or data** can occur if the instructions are disregarded or not strictly observed!





Attention

This symbol is used if **precautionary measures must be taken** when handling electrostatically sensitive components.

1.2.3 Notification symbols

	Note	This symbol is used to draw your special attention to a remark.
	Reference	This symbol refers to additional information in other documents, chapters or sections.
abc ¹	Footnote	Footnotes are comments, referring to specific parts of the text . They consist of 2 parts: 1) Markings in the text are arranged as continuous superscript numbers 2) Footnote text is placed at the bottom of the page and starts with a number and a period
*	Action	An asterisk indicates that a required action is described. The individual steps are indicated by asterisks, for example: * Press 

1.2.4 Presentation

	Buttons	Buttons are shown in a circle. Either symbols or text are possible. If a button has multiple assignments, the text shown is always the text corresponding to the function currently used.
 + 	Button combinations	Two buttons shown in combination with a plus sign means that they must be pressed simultaneously.
ConF → InP → InP1	Command chain	Arrows between words serve for finding parameters at the configuration level more easily or for navigating in the ACS411 setup program.

1.3 Description

Use in heating plants	The RWF55 is used primarily for the control of temperature or pressure in oil- or gas-fired heating plants. Depending on the setting, it is employed as a compact 3-position controller or as a modulating controller with an analog output. An external switch is provided to convert it to a 2-position controller for controlling 2-stage burners. The built-in thermostat function switches the burner on and off.
Cooling controller	The controller's operating mode can be changed from heating to cooling, or vice versa. ⇒ Reference! See chapter 8.4 <i>Controller Cntr.</i>
RWF55	The controllers feature two 4-digit 7-segment displays for the actual value (red) and the setpoint (green). The RWF55 has a 3-position output consisting of 2 relays to open or close a controlling element. There is also an analog output and a multifunctional relay (K6), which can be used to set 12 different switching functions.
Interface	The controllers feature an RS-485 interface Modbus slave as standard.
Option	Additionally, the RWF55.6 features a Profibus DP interface.
Control	In modulating mode, the RWF55 operates as a PID controller. In 2-stage mode, the RWF55 provides control based on the set switching threshold. You have the option of specifying the setpoint of the RWF55 on the controller or externally via an interface. The user uses it for control the temperature or pressure of a heating boiler or cooling system. It is possible to adjust the minimum and maximum setpoint limits. 2 binary inputs are used to execute functions such as setpoint changeover, setpoint shifting or operating mode changeover. Standard feature is a self-setting function used to determine the PID control parameters.
Mounting	The controller insert measures 48 x 96 x 122 mm and is especially suited for installation in control panels. All electrical connections are made via screw terminals at the rear of the unit.

1.4 Block structure

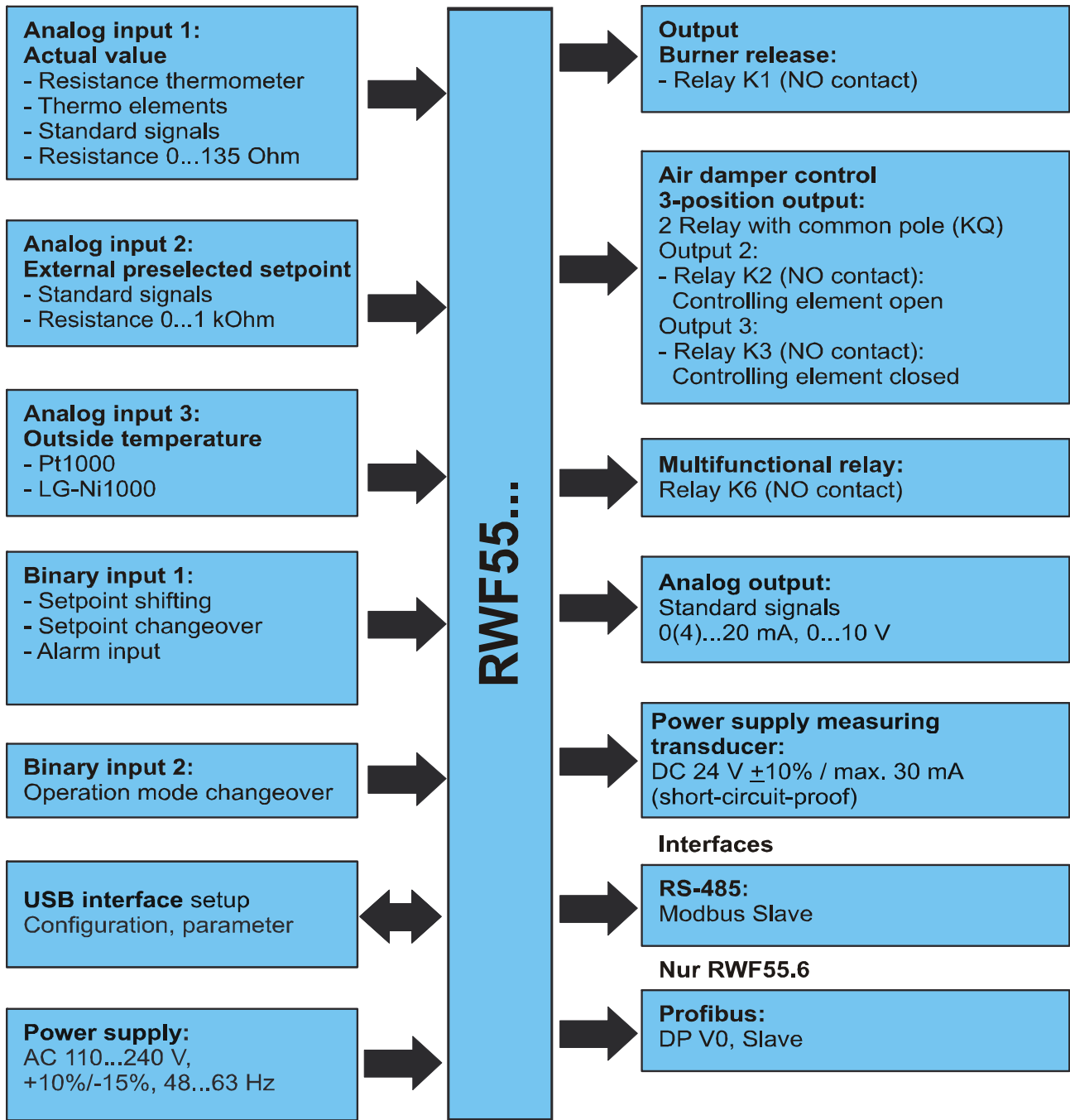

7867d01e/0313

Figure 1: Block structure

2 Identification of product no.

2.1 Type field

Location:

The type field is glued onto the housing. The arrow below indicates the product no.

Example

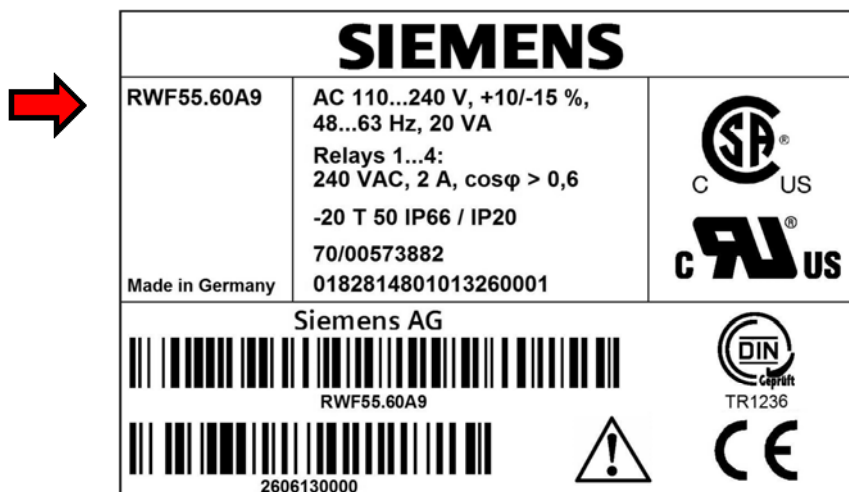

Attention!

Mains supply must correspond to the operating voltage given on the type field.

Product nos. :

Product no.	Description
RWF55.50A9	Full version with 3-position output, analog output, RS-485 – single pack
RWF55.51A9	Full version with 3-position output, analog output, RS-485 – multipack (20 pieces)
RWF55.60A9	Full version with 3-position output, analog output, RS-485 Profibus-DP – single pack
RWF55.61A9	Full version with 3-position output, analog output, RS-485 Profibus-DP – multipack (20 pieces)

2.2 Scope of delivery

- Type of controller as ordered
- User Manual (only single pack)

3 Installation

3.1 Installation site and climatic conditions

- The installation site should be free from vibrations, dust and corrosive media
- The controller should be installed away from sources of electromagnetic fields, such as variable speed drives or high-voltage ignition transformers

Relative humidity: $\leq 95\%$ (noncondensing)

Ambient temperature: $-20 \dots 50 \text{ }^\circ\text{C}$

Storage temperature: $-40 \dots 70 \text{ }^\circ\text{C}$

3.2 Dimensions

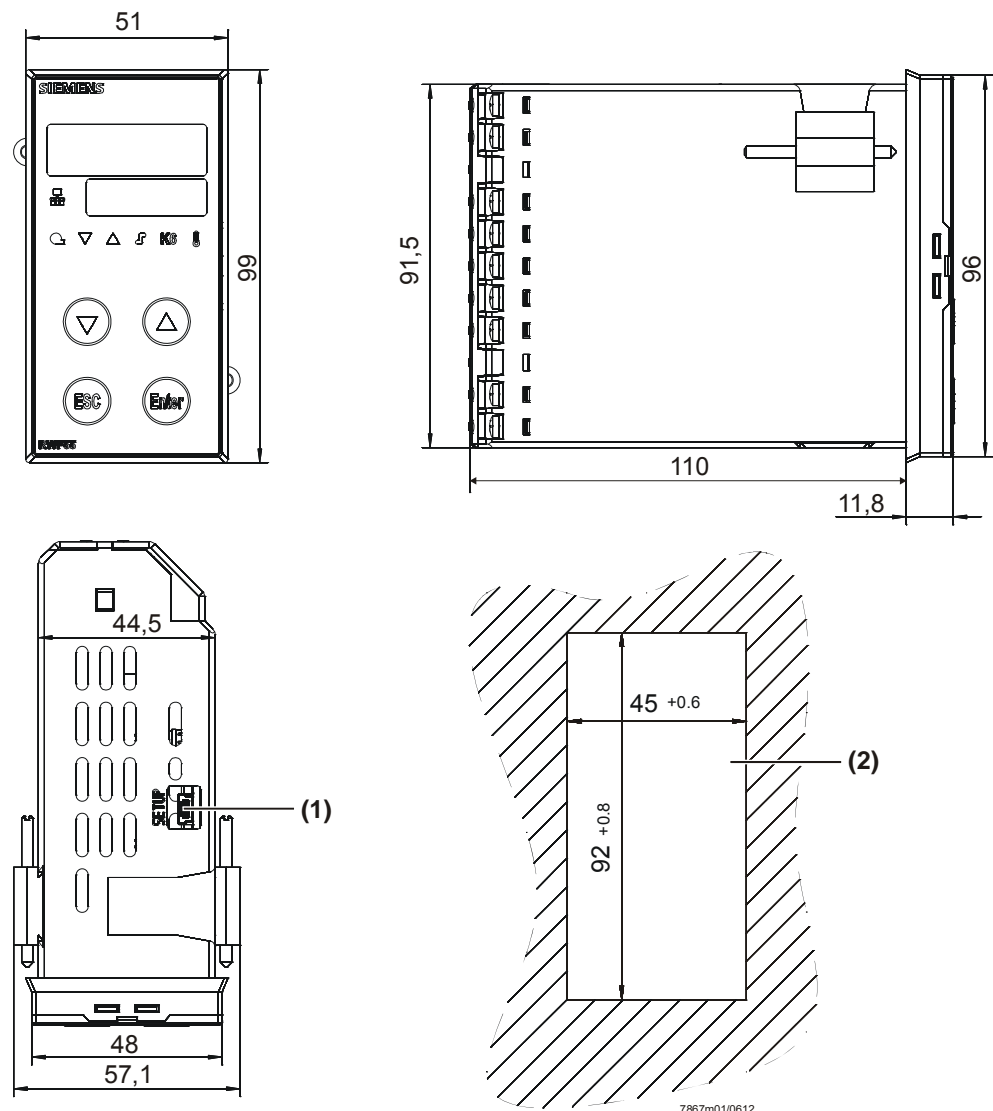

Figure 2: Dimensions of RWF55

Key

- (1) USB interface setup
- (2) Panel cutout

3.3 Side-by-side mounting

If several controllers are mounted side-by-side or above one another in a control panel, the horizontal distance between panel cutouts must be a minimum of 11 mm and the vertical distance a minimum of 50 mm.

3.4 Mounting the controller in a panel cutout

- * Remove the mounting clips
- * Fit the seal supplied with the controller



Attention!

The controller must be installed with the seal, preventing water or dirt from entering the housing!

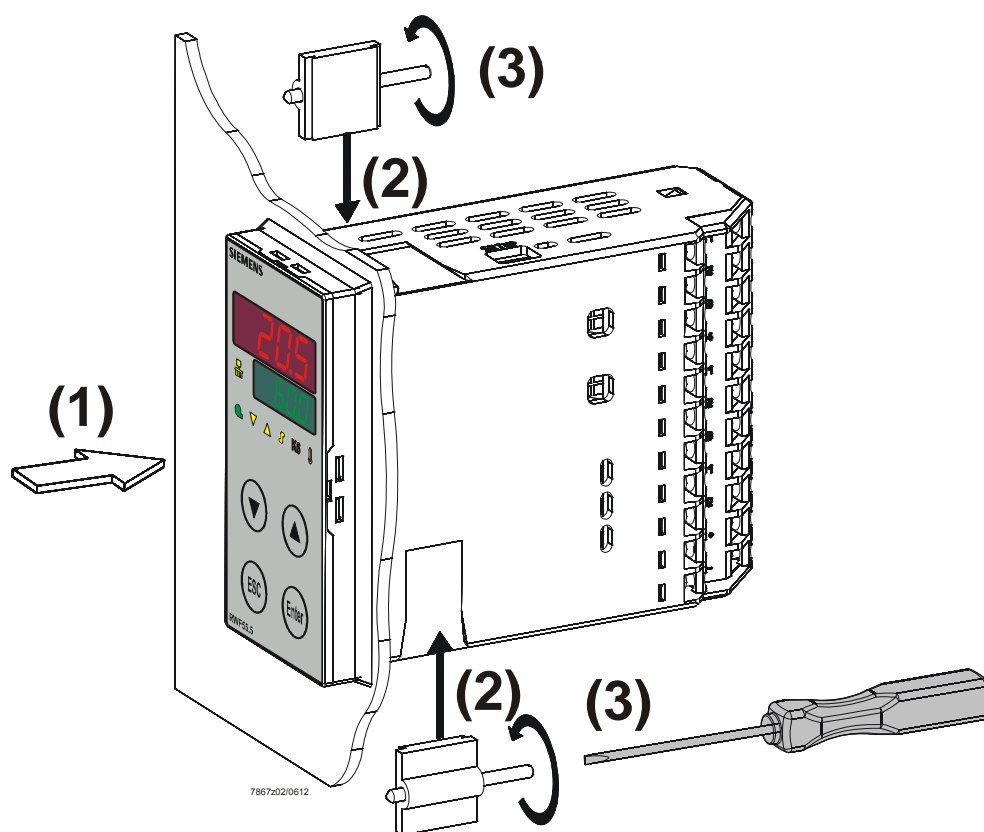

Figure 3: Mounting in a panel cutout

- * Insert the controller from the front into the panel cutout (1) and make certain the seal is correctly fitted
- * Working from the rear side of the panel, push the mounting clips into the guide slots on the side of the controller (2) and tighten them evenly using a screwdriver (3) until the controller housing is seated firmly in the panel cutout.

3.5 Removing the controller from the panel cutout



Attention!

When removing the controller, make certain that all cables are disconnected and that they do not get squeezed between control panel and housing.

3.6 Cleaning the front

The front of the controller can be cleaned with normal washing/rinsing agents or detergents.



Attention!

The front of the controller is **not** resistant to corrosive acids, caustic solutions and abrasive cleaners. Do not clean with high-pressure cleaners!

4 Electrical connections

4.1 Installation notes

Safety regulations

- The choice of cable, installation and electrical connections of the controller must conform to VDE 0100 *Regulations for the installation of power circuits with nominal voltages below AC 1000 V*, or the relevant local regulations
- The electrical connections must be made by qualified personnel
- If contact with live parts is possible while working on the unit, the controller must be disconnected from power supply (all-polar disconnection)
- When connecting the RWF55 to an external PELV circuit, the existing internal SELV circuit becomes a PELV circuit.
The protection against electric shock hazard through double or reinforced insulation and voltage limitation is still present.
No connection to protective earth is required.
- Equipment connected to the SELV circuit must have a safe separation from dangerous contact voltages in accordance with DIN EN 61140 (e.g. through double or reinforced insulation in accordance with DIN EN 60730-1).

Connection of external components



Caution!

When connecting external components to the safety extra low-voltage inputs or outputs of the RWF55 (terminals 11, 12, 13, 14, 21, 22, 23, 31, 32, D1, D2, DG, G+, G-, A+, A- and USB port, RS-485- and Profibus interface), it must be made certain that no dangerous active voltage are introduced to the RWF55. This can be achieved by using capsulated components with double/reinforced insulation or SELV components, for example. If not observed, there is a risk of electric shock.

Screw terminals



Caution!

All screw terminals at the rear of the unit must always be properly tightened. This applies to unused terminals as well.

Fusing



Caution!

- Fusing on site must not exceed 20 A
- The fuse on the controller side (AC 250 V/1.6 A slow) conforms to IEC 60127-4
- To prevent the relay contacts from welding in the event of short-circuit in the load circuit, fusing of the output relays must give consideration to the maximum permissible relay current
 - ⇒ Reference!
See chapter 14.3 *Controller outputs* OutP.
- No other loads may be connected to the controller's main power supply terminals

Suppression of interference

- The electromagnetic compatibility and interference suppression levels conform to the standards and regulations listed under *Technical data*
 - ⇒ Reference!
See chapter 14.5 *Electrical data*.
- Input, output and supply cables should be routed separately, not parallel to one another
- All input and output lines without connection to the power supply network must be shielded and twisted. They must not be run close to live components or live cables.

Incorrect use

- The controller is not suited for installation in areas with explosion hazard
- Incorrect settings on the controller (setpoint, data of parameter and configuration levels) can affect proper functioning of the process or lead to damage.
Safety devices independent of the controller, such as overpressure relief valves or temperature limiters/monitors should therefore always be provided, and only be capable of adjustment by qualified personnel. Please observe the relevant safety regulations. Since self-setting cannot be expected to handle all possible control loops, the stability of the resulting actual value should be checked

4.2 Galvanic separation

The illustration shows the maximum test voltages between the electrical circuits.

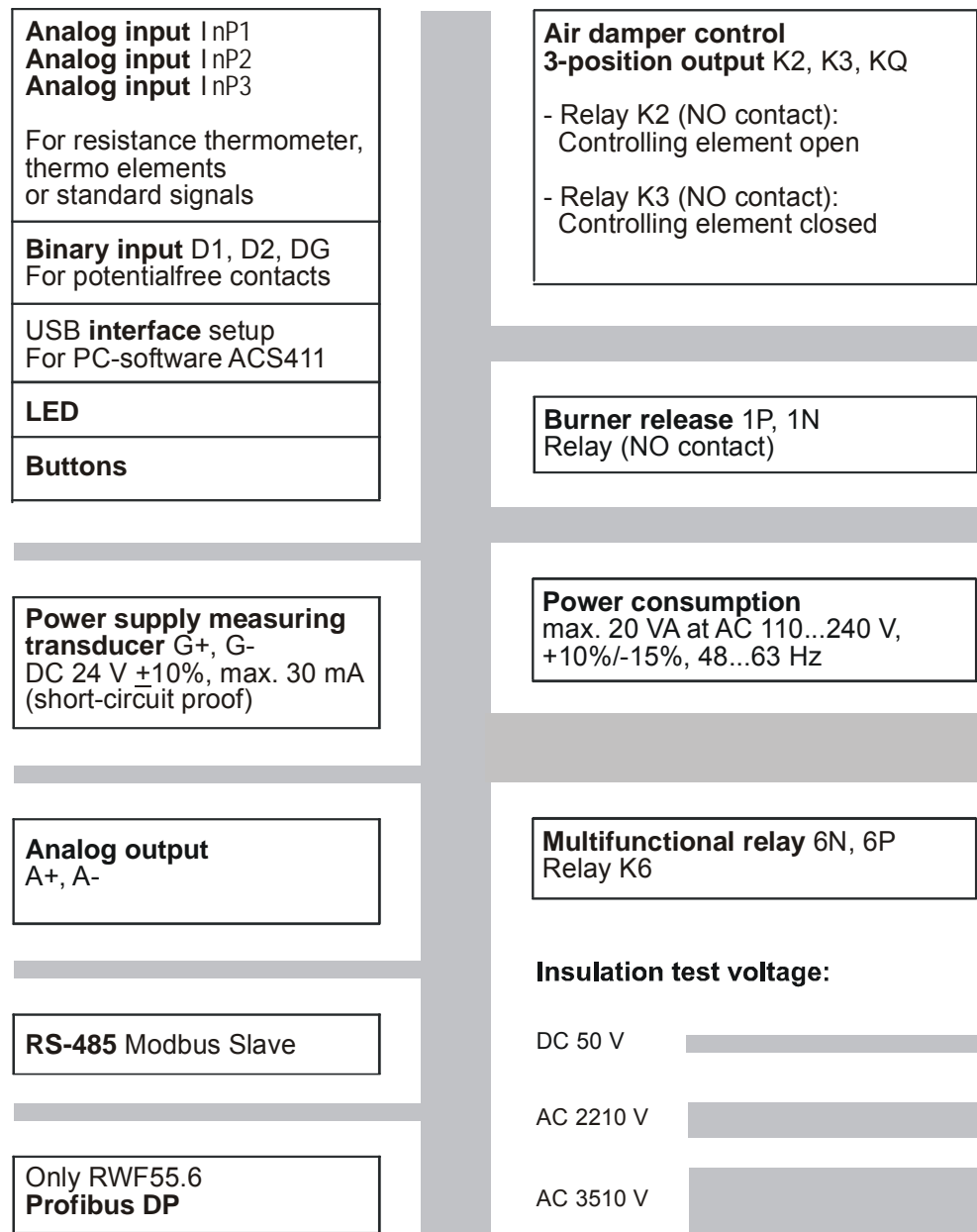

7867d02e/0712

Figure 4: Test voltages

4.3 Assignment of terminals



Caution!
Electrical connections must always be made by qualified personnel!

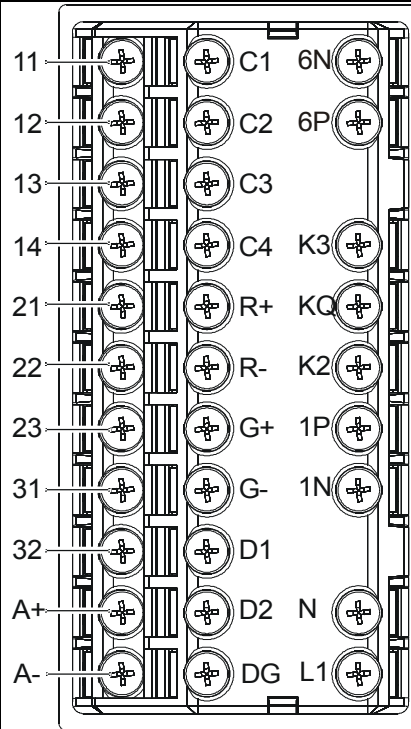

7867z01/0712

Figure 5: Assignment of terminals

Outputs	Display LED	Terminal no.	Connection diagram
Relay <i>Burner release</i> : Relay K1: 1P, 1N		1P pole 1N NO contact	
3-position output: Relay K3: Controlling element CLOSE Relay K2: Controlling element OPEN	 	K3 NO contact KQ common pole K2 NO contact	
Multifunctional relay K6: 6N, 6P	K6	6N NO contact 6P pole	
Analog output A+, A- DC 0(4)...20 mA, DC 0...10 V		A+ A-	

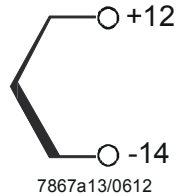
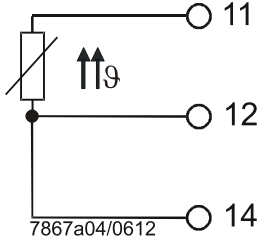
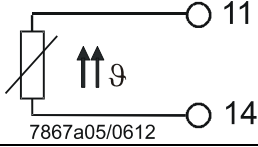
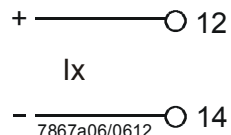
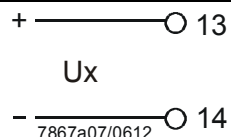
Analog input I nP1 (actual value)	Terminal no.	Connection diagram
Thermal element	12 14	 7867a13/0612
Resistance thermometer in 3-wire circuit	11 12 14	 7867a04/0612
Resistance thermometer in 2-wire circuit 0...135 Ω	11 14	 7867a05/0612
Current input DC 0...20 mA, 4...20 mA	12 + 14 -	 7867a06/0612
Voltage input DC 0...5 V, DC 1...5 V, DC 0...10 V	13 + 14 -	 7867a07/0612

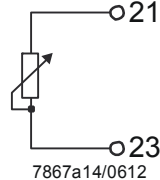
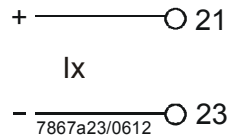
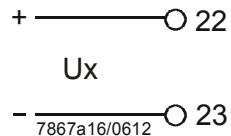
Analog input I nP2 (external setpoint or setpoint shifting)	Terminal no.	Connection diagram
Resistance thermometer in 2-wire circuit 0...1000 Ω	21 23	 7867a14/0612
Current input DC 0...20 mA, 4...20 mA	21 + 23 -	 7867a23/0612
Voltage input DC 0...5 V, 1...5 V, 0...10 V	22 + 23 -	 7867a16/0612

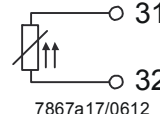
Analog input I nP3 (outside temperature)	Terminal no.	Connection diagram
Resistance thermometer in 2-wire circuit	31 32	 7867a17/0612

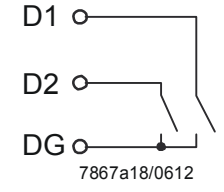
Binary inputs binF	Terminal no.	Connection diagram
Binary input D1	D1	
Binary input D2	D2	
Common ground DG	DG	

Power supply	Terminal no.	Connection diagram
Power supply AC 110...240 V +10%/-15%, 48...63 Hz	L1 Live conductor	L1 ○ ———
	N Neutral conductor	N ○ ——— 7866a09/0911
Power supply measuring transducer (short-circuit-proof)	G+ G-	G+ ○ ——— + DC 24 V \pm 10% max. 30 mA G- ○ ——— 7867a10/0612

Interface	Terminal no.	Connection diagram
RS-485	R+ R-	RxD/TxD + RxD/TxD -
Only RWF55.6 Profibus DP	C1 C2 C3 C4	VP (+5 V) RxD/TxD-P (B) RxD/TxD-N (A) DGND

5 Operating modes

5.1 Low-fire operation

Low-fire operation means that only small amounts of heat are drawn from the boiler. Using relay K1 *Burner release*, the 2-position controller ensures control to the setpoint by switching the burner on and off like a thermostat.

Thermostat function

This mode of control is known as the **thermostat function**. An adjustable switching difference ensures that the burner's switching frequency can be selected, aimed at reducing wear.

Heating controller

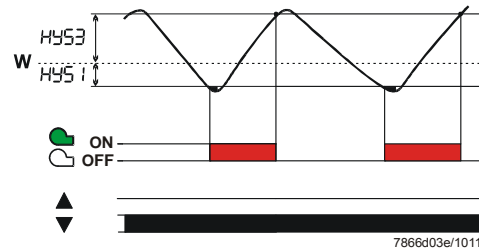

Figure 6: Control sequence of heating controller

Modulating and 2-stage operation:

Actual value lies between switch-on threshold HYS1 and switch-off threshold HYS3.

Cooling controller

If the controller is set to cooling mode, temperature limits HYS4 and HYS6 apply. In that case, relay K1 *Burner release* is used for controlling the cooling equipment.

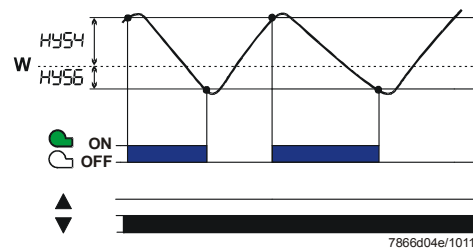

Figure 7: Control sequence of cooling controller

Modulating and 2-stage operation:

Actual value lies between switch-on threshold HYS4 and switch-off threshold HYS6.

5.2 High-fire operation

High-fire operation means that large amounts of heat are drawn from the boiler so that the burner runs continuously. If the heating load during low-fire operation rises to a level where the actual value begins to fall below switch-on threshold HYS1, the controller will not immediately switch to a higher burner output, but first makes a dynamic test of the control deviation and switches to the higher output only when an adjustable threshold (q) is exceeded (A).

⇒ Reference!
See chapter 5.6 *Response threshold (q)*.

Operating mode changeover

- In high-fire operation – depending on the application – the burner can be fired in **modulating** or **2-stage** operation, then burning larger amounts of fuel than in low-fire operation. **Binary input D2** can be used to switch between modulating and 2-stage operation
 - Contacts **D2** and **DG** open: Modulating burner operation
 - Contacts **D2** and **DG** closed: 2-stage burner operation

⇒ Reference!
See chapter 8.8 *Binary functions bi nF*.

5.2.1 Modulating burner, 3-position output

Area (1)

In area (1), the thermostat function is active. The lowest burner stage is switched on below switch-on threshold HYS1 and switched off above switch-off threshold HYS3.

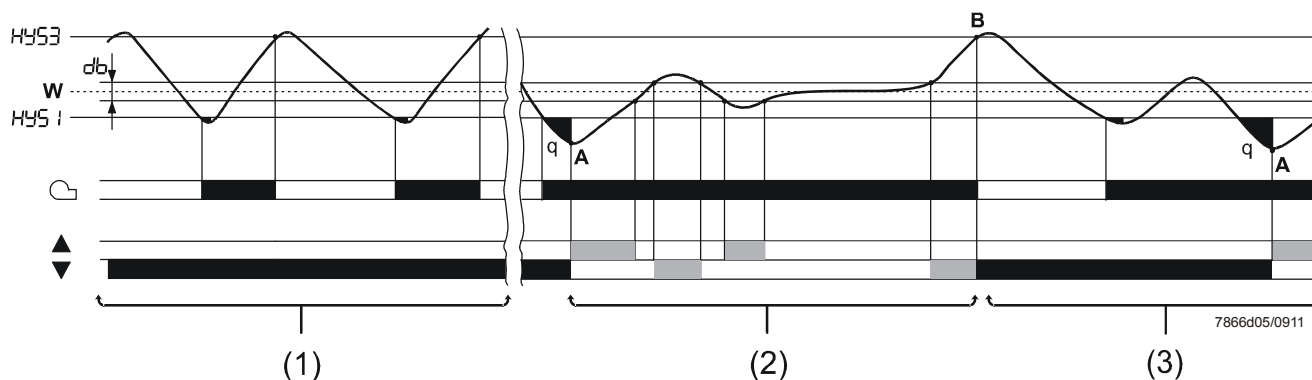

Figure 8: Control sequence of modulating burner, 3-position output

Area (2)

Here, operating mode *Modulating burner* is shown. In high-fire operation, the 3-position controller acts on an actuator via relay K2 (OPEN) and relay K3 (CLOSE). When the actual value falls below the setpoint, the response threshold (q) at point (A) is reached and the controlling element opens (greater heat output). When the actual value lies within the dead band db, the controlling element remains inactive. When the actual value exceeds db, the controlling element closes (smaller heat output).

Area (3)

If the actual value exceeds the upper switch-off threshold HYS3 in spite of the lowest heating stage, the controller switches the burner off (B). The controller only starts low-fire operation when the actual value falls below switch-on threshold HYS1 again. If the response threshold (q) is exceeded, the controller switches to high-fire operation (A).

⇒ Reference!
See chapter 5.6 *Response threshold (q)*.

5.2.2 Modulating burner, analog output

Area (1) Thermostat function active.

Area (2) The RWF55 as a modulating controller provides control to the adjusted setpoint. Angular positioning is ensured via the analog output in the form of a standard signal.

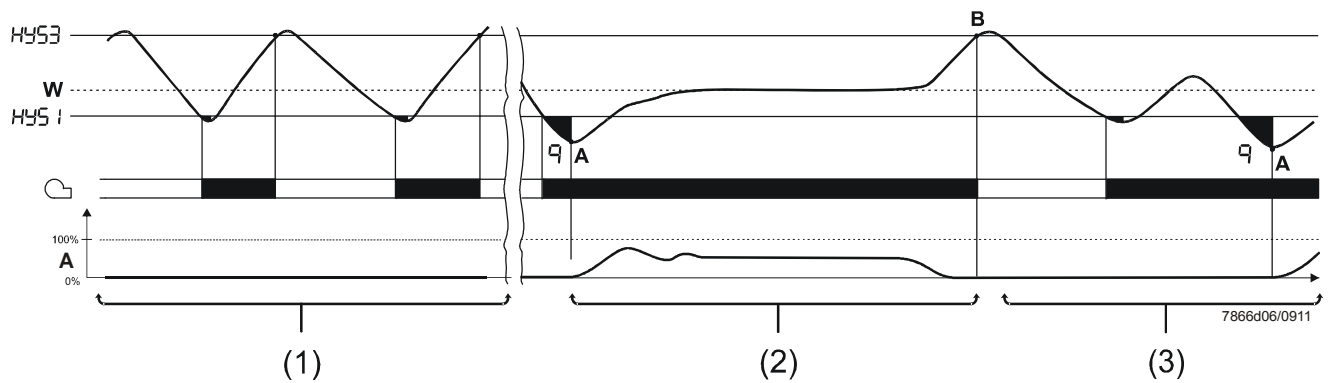

Figure 9: Control sequence of modulating burner, analog output

Area (3) The controller behaves as described in chapter 5.2.1 *Modulating burner, 3-position output*.

Cooling controller If the controller is set to cooling mode, the respective values HYS4 and HYS6 apply.

Starting from a high actual value, the controller now controls the connected cooling equipment in low-fire operation. In high-fire operation, the cooling output is controlled via relays K2 and K3 or the analog output. The response threshold (q) calculates automatically (now in the reverse sense) the point from which the cooling output is to be increased.

Output Angular positioning is ensured via the analog output in the form of a standard signal.



Note!
The modulating controller must be configured.



Reference!
See chapter 8.4 *Controller Cntr*

5.2.3 2-stage burner, 3-position output

In area (1), the thermostat function is active. In area (2), the RWF55 as a **2-position controller** acts on the second stage via relay K2 (OPEN) and relay K3 (CLOSE) by switching on at switch-on threshold HYS1 and switching off at switch-off threshold HYS2.

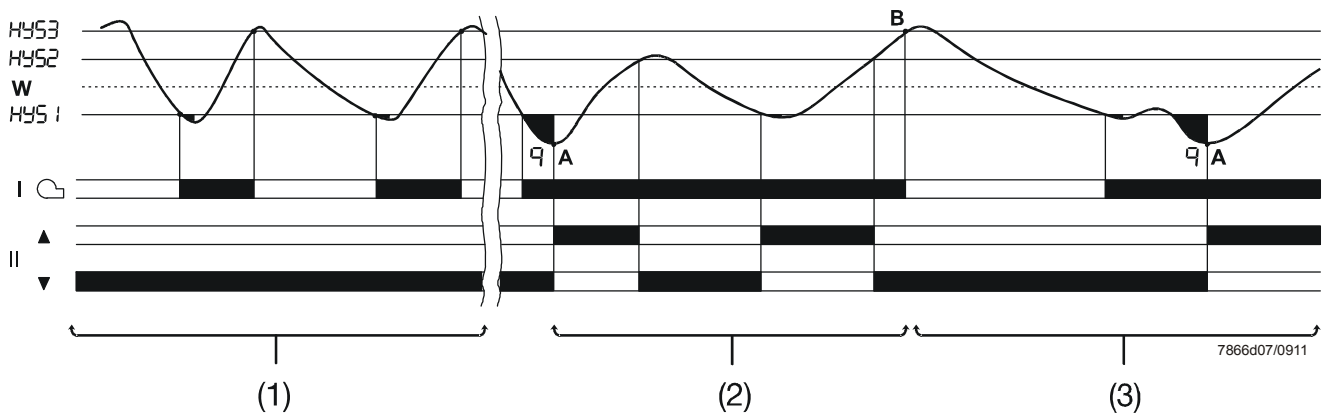

Figure 10: Control sequence of 2-stage burner, 3-position output

In area (3), the actual value exceeds the upper switch-off threshold HYS3 and the controller shuts down the burner (**B**). The controller only starts low-fire operation when the actual value falls again below switch-on threshold HYS1. If the response threshold (q) is exceeded, the controller switches to high-fire operation (**A**).

⇒ Reference!
 See chapter 5.6 *Response threshold (q)*.

5.2.4 2-stage burner, analog output

In this case, a digital standard signal switches the second stage on via the analog output (terminals **A+** and **A-**) when reaching switch-on threshold **HYS1** and off at the lower switch-off threshold **HYS2**.

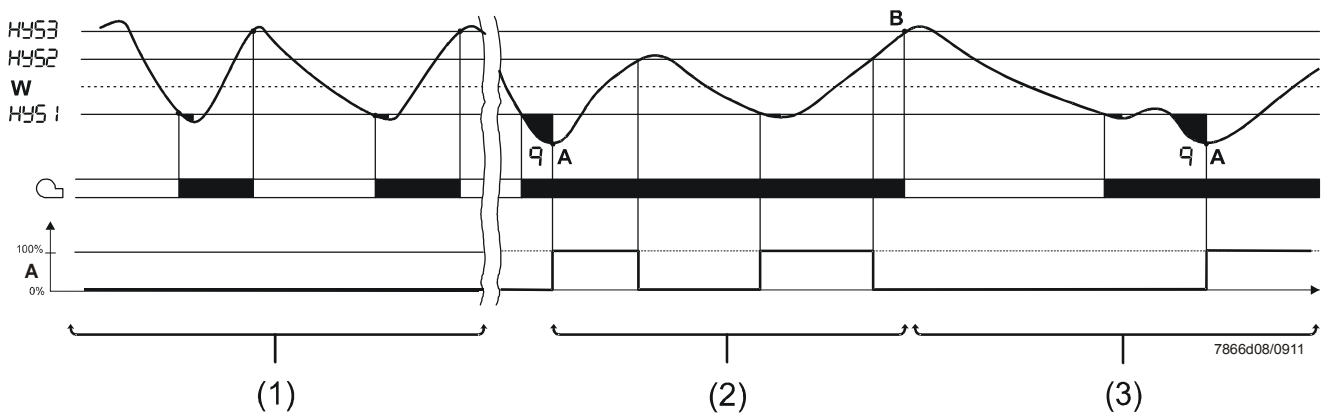

Figure 11: Control sequence of 2-stage burner, analog output

Cooling controller

If the controller is set to cooling mode, the respective values of **HYS4**, **HYS5** and **HYS6** apply.

Starting from a high actual value, the controller now controls the connected cooling equipment in low-fire operation. In high-fire operation, the second stage and thus the cooling output are controlled via relays **K2** and **K3** or the analog output. The response threshold (**q**) calculates automatically (now in the reverse sense) the point from which the cooling output is to be increased.

5.3 Burner shutdown

In the event of a sensor failure, the controller cannot monitor the actual value of the boiler temperature (analog input I nP1). Burner shutdown will automatically be triggered to guard against overheating.

The same applies to acquiring the external setpoint using analog input I nP2.

Functions

- Burner off
- 3-position output for closing the controlling element
- Self-setting function is ended
- Manual control is ended

5.4 Predefined setpoint

The setpoints (SP1, SP2 or dSP) are predefined within the selected setpoint limits via the buttons or the ACS411 software.

It is possible to shift the setpoint using either an analog or a binary signal, to change it via an external contact, or to influence it using a weather-compensated method.

⇒ Reference!
See chapter 8.8 *Binary functions* bi nF.

Setpoint changeover	Shifting	Binary input D1	Information	
SP1	Analog via I nP2	Open	⇒	Reference! See chapter 5.4.1 <i>Setpoint changeover SP1/SP2, or shifting analog via I nP2</i>
SP2	Analog via I nP2	Closed		
SP1		Open	⇒	Reference! See chapter 5.4.2 <i>Setpoint changeover SP1 / external setpoint via I nP2</i>
External setpoint via I nP2		Closed		
	Setpoint SP1 analog via I nP2, no binary shifting	Open	⇒	Reference! See chapter 5.4.3 <i>Setpoint shifting SP1 analog via I nP2 / binary via dSP</i>
	Setpoint SP1 analog via I nP2, binary shifting about setpoint dSP	Closed		
	External setpoint via I nP2, no binary shifting	Open	⇒	Reference! See chapter 5.4.4 <i>External setpoint, setpoint shifting binary via dSP</i>
	External setpoint via I nP2, binary shifting about setpoint dSP	Closed		

5.4.1 Setpoint changeover SP1 / SP2 or setpoint shift analog via InP2

⇒ See chapter 8.3 *Analog input InP3*

InP3 (outside temperature)
SEn3 = 1, 2

⇒ See chapter 5.5 *Weather compensated setpoint shifting*

Heating curve
Factory setting: At1 = -10, Ht1 = 60, At2 = 20, Ht2 = 50

⇒ See chapter 7 *Parameterization PArA*

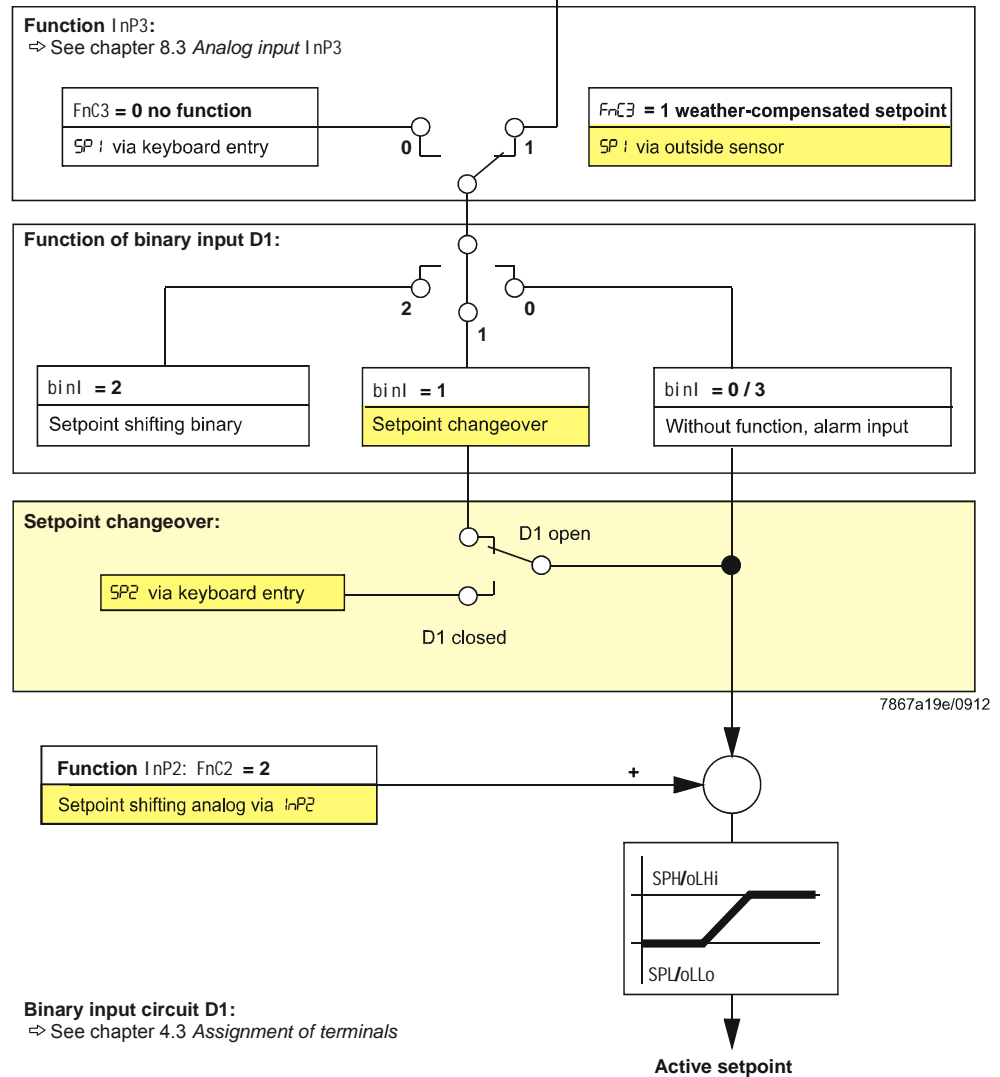

Figure 12: Setpoint changeover or setpoint shift

5.4.2 Setpoint changeover SP1 / external setpoint via InP2

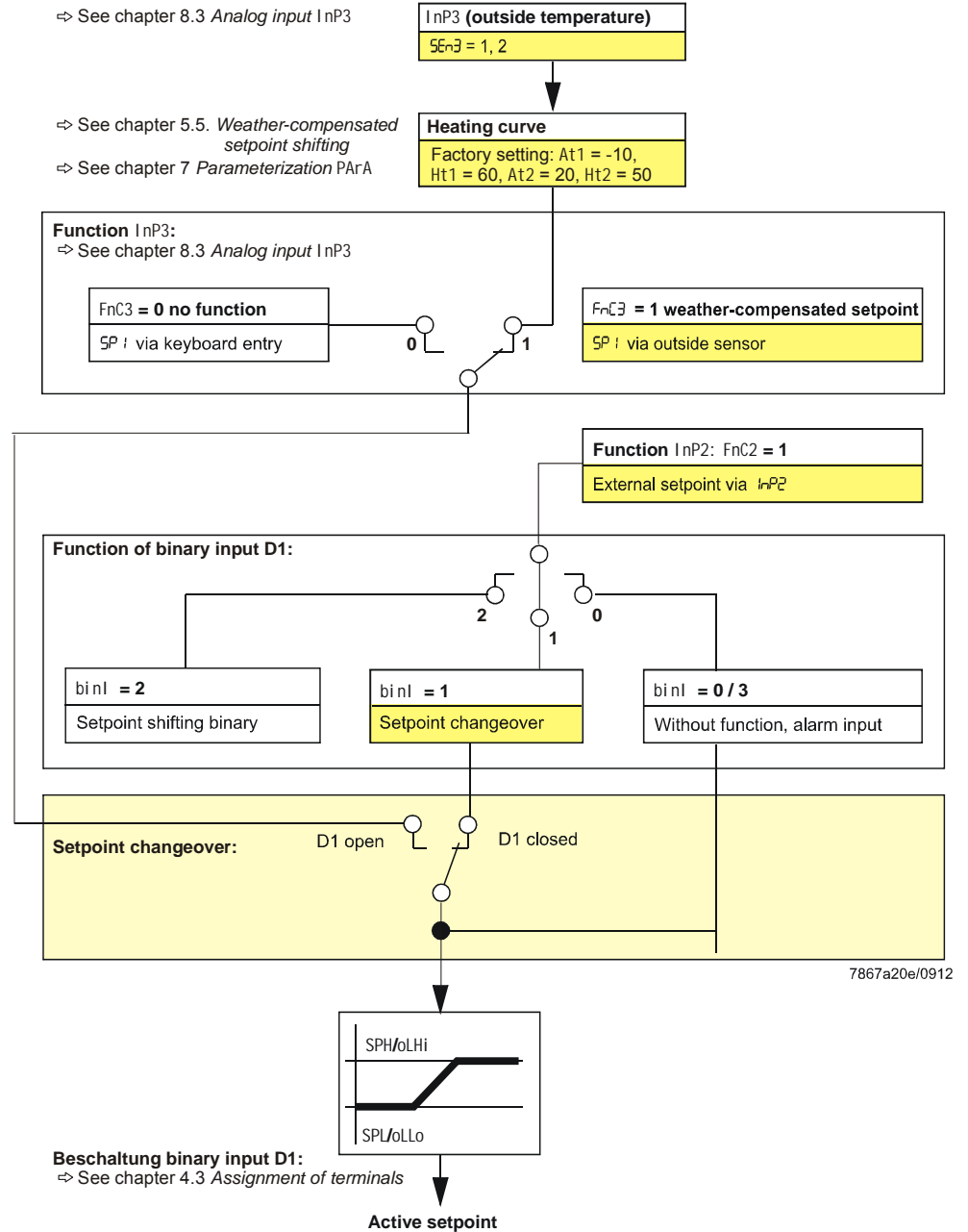

Figure 13: Setpoint changeover SP1 / external setpoint

5.4.3 Setpoint shifting SP1 analog via InP2 / binary via dSP

⇒ See chapter 8.3 *Analog input InP3*

InP3 (outside temperature)
SEn3 = 1, 2

⇒ See chapter 5.5 *Weather-compensated setpoint shifting*
⇒ See chapter 7 *Parameterization PAR.A*

Heating curve
Factory setting: At1 = -10, Ht1 = 60, At2 = 20, Ht2 = 50

Function InP3:
⇒ See chapter 8.3 *Analog input InP3*

FnC3 = 0 no function
SP1 via keyboard entry

FnC3 = 1 weather-compensated setpoint
SP1 via outside sensor

Function InP2: FnC2 = 2
Setpoint shifting analog via InP2

Function of binary input D1:

bin1 = 2
Setpoint shifting binary

bin1 = 1
Setpoint changeover

bin1 = 0 / 3
Without function, alarm input

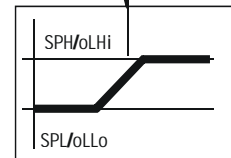
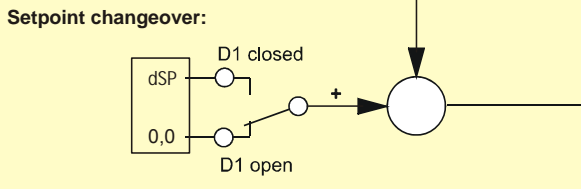

Beschaltung binary input D1:
⇒ See chapter 4.3 *Assignment of terminals*

Active setpoint

Figure 14: Setpoint shifting analog / binary

5.4.4 External setpoint, setpoint shifting binary via dSP

⇒ See chapter
8.2 Analog input InP2

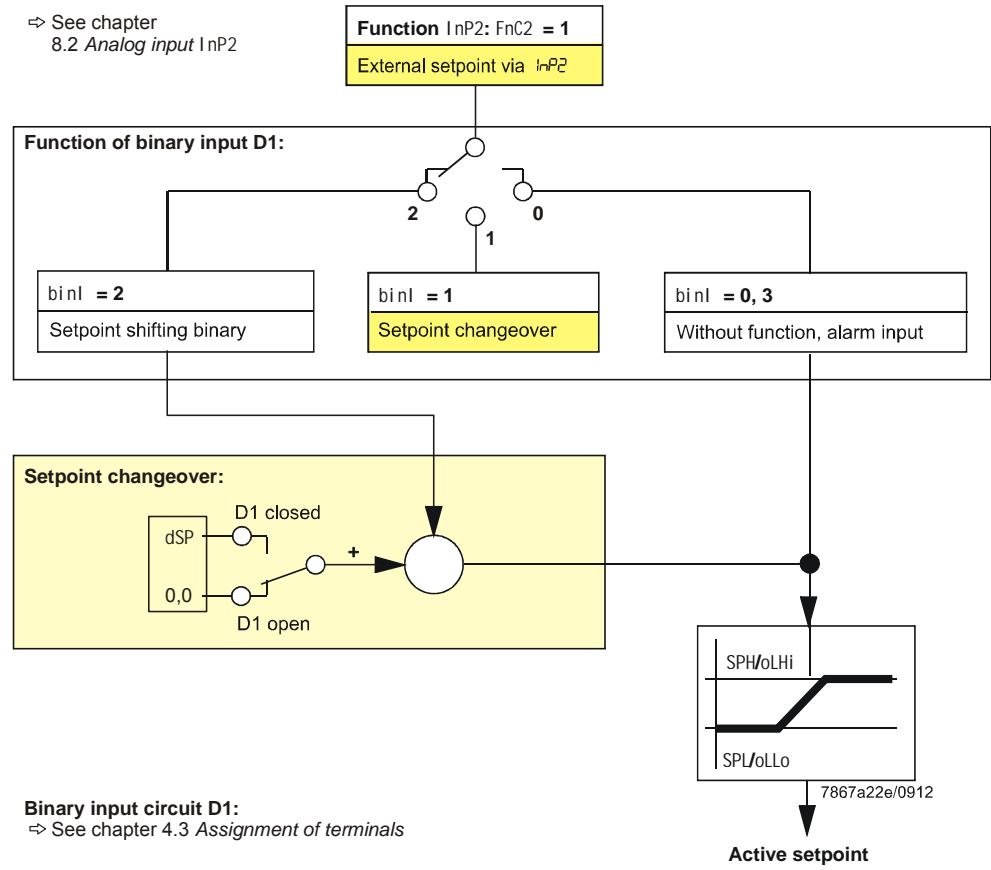

Binary input circuit D1:
⇒ See chapter 4.3 Assignment of terminals

Figure 15: External setpoint, setpoint shifting binary via dSP

5.5 Weather-compensated setpoint shifting

The RWF55 can be configured so that weather-compensated setpoint shifting is activated when an LG-Ni1000 outside sensor or a Pt1000 is connected.

⇒ Reference!
See chapter 8.3 *Analog input I nP3*

To take into account the time response of a building, weather-compensated setpoint shifting uses the attenuated outside temperature rather than the current outside temperature.

This attenuated outside temperature is determined on the basis of the current outside temperature and a filter constant. With the RWF55, this filter value (parameter dF3) can be adjusted. In the event of a power failure, this filter is reset. The minimum and maximum setpoints can be set using the lower setpoint limit SPL and the upper setpoint limit SPH.

The system also prevents the lower working range limit oLl0 and upper working range limit oLHi from exceeding/dropping below the system temperature limits.

👉 **Note!**
Each RWF55 must have its own separate outside sensor (no parallel connection).
This function has been optimized for heating systems with DHW.

Heating curve

The heating curve describes the relationship between the boiler temperature setpoint and the outside temperature. It is defined by 2 curve points. For 2 outside temperatures, the user defines the boiler temperature setpoint that is required in each case. The heating curve for the weather-compensated setpoint is calculated on this basis. The effective boiler temperature setpoint is limited by the upper setpoint limit SPH and the lower setpoint limit SPL.

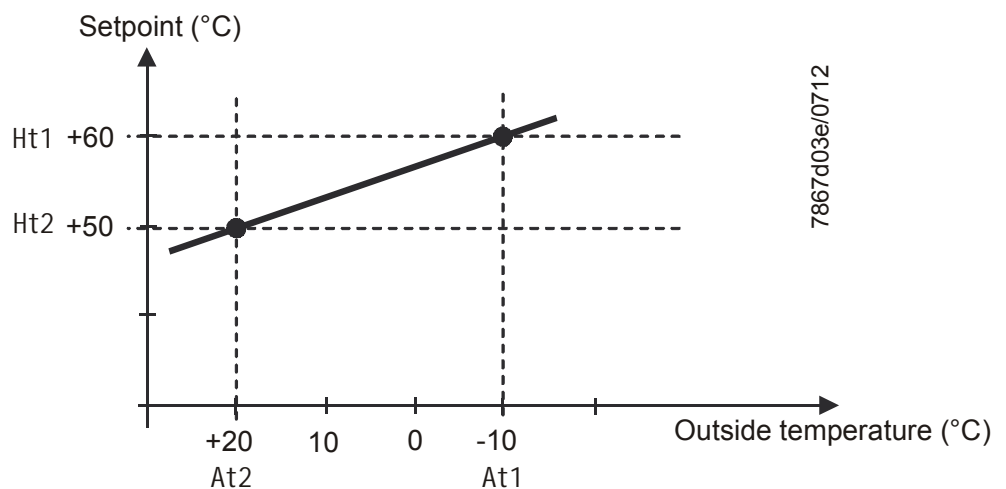

Figure 16: Heating curve slope

The two curve points are set at the parameter level.

⇒ Reference!
See chapter 7 *Parameterization PArA*

5.6 Response threshold (q)

The response threshold (q) defines for what period of time and how much the actual value is allowed to drop before the system switches to high-fire operation.

An internal mathematical calculation using an integration function determines the sum of all areas $q_{eff} = q_1 + q_2 + q_3$ as shown in the graph. This takes place only when the control deviation $(x-w)$ falls below the value of switch-on threshold HYS1. If the actual value increases, integration is stopped.

If q_{eff} exceeds the preset response threshold (q) (can be adjusted at the parameter level), this causes the second burner stage to switch on or – in the case of the 3-position controller/modulating controller – the controlling element to open.

If the current boiler temperature reaches the required setpoint, q_{eff} is reset to 0.

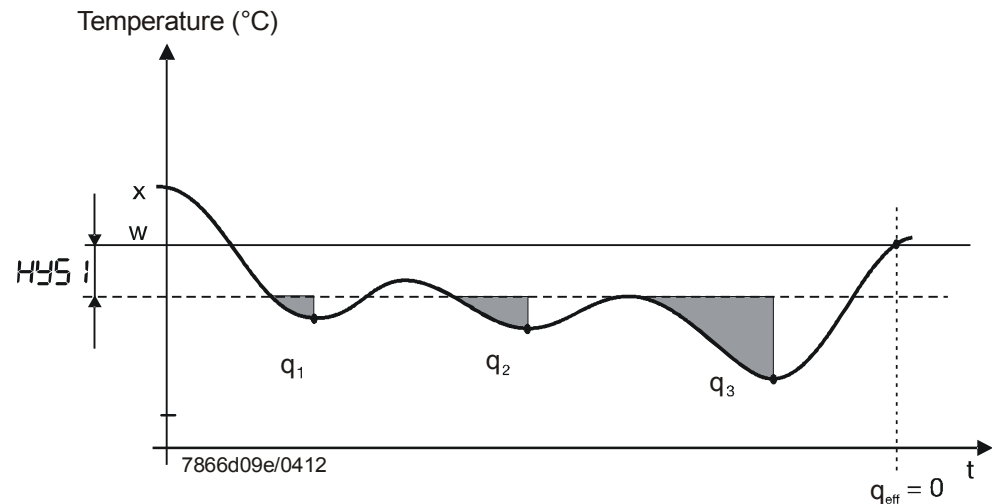

Figure 17: Control sequence response threshold (q)

In contrast to time-dependent switching on, load-dependent switching on offers the advantage of capturing the dynamics of the actual value.

Also, monitoring the progression of the actual value during the change from low-fire to high-fire ensures low switching frequencies to reduce wear and to extend running times.

Cooling controller

The response threshold (q) also works (in the reverse sense) in the case of cooling mode.

5.7 Cold start of plant

Interlocking



Note!

Functions *Cold start of plant* and *Thermal shock protection (TSS)* are interlocked. Only one function can be activated, but never both at the same time.

Heating controller

When a heating system is switched off for a longer period of time, the actual value will drop of course.

To achieve a faster control response, the controller immediately starts in high-fire operation as soon as the control deviation ($x-w$) drops below a certain limit value.

This limit is calculated as follows:

$$\text{Limit value} = 2 \times (\text{HYS1} - \text{HYS3})$$

In that case, the response threshold (q) is inactive, independent of operating mode and controlled variable (temperature or pressure).

Example

Operating mode: Modulating, 3-position output

HYS1 = -5 K

HYS3 = +5 K

$w = 60 \text{ }^\circ\text{C}$

$$\text{Limit value} = 2 \times (-5 - 5) = 2 \times (-10) = -20 \text{ K}$$

At an actual value below $40 \text{ }^\circ\text{C}$, heating is immediately started in high-fire mode in place of low-fire mode.

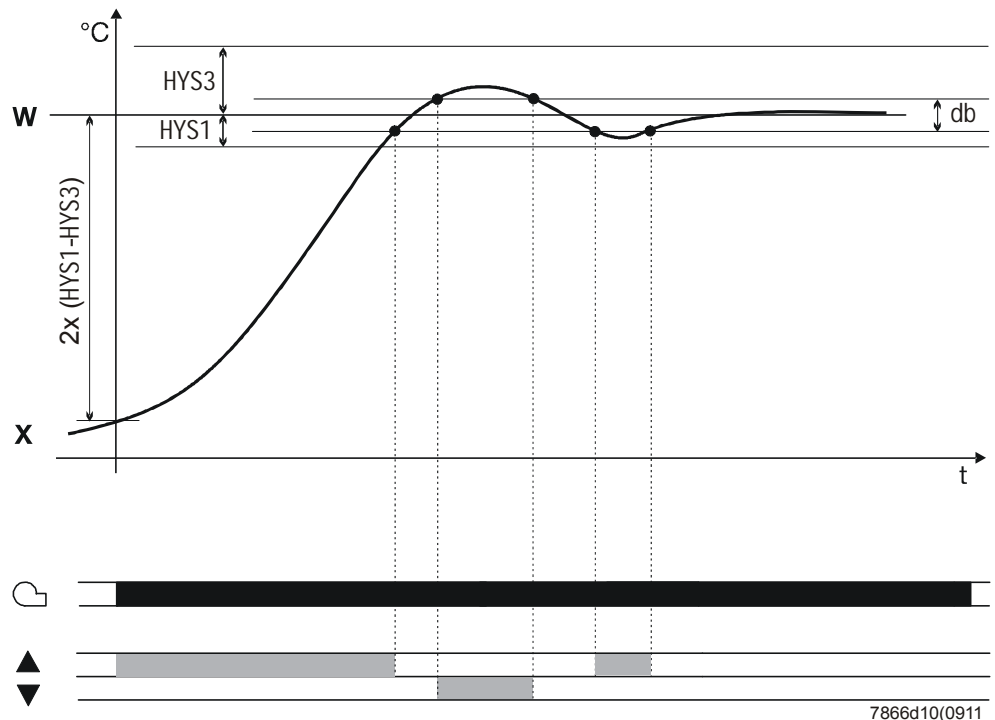

Figure 18: Control sequence *Cold start of plant*

7866d10(0911

Cooling controller

Cold start of plant also works when the RWF55 is used as a cooling controller.

In that case, the limit value is calculated as follows:

Limit value = $2 \times (\text{HYS4} - \text{HYS6})$

Example

Operating mode: Modulating 3-position output

HYS4 = 5 K

HYS6 = -5 K

w = -30 °C

Limit value = $2 \times (5 + 5) = 2 \times (10) = +20 \text{ K}$

When the actual value lies above -10 °C, cooling is immediately started in high-fire mode in place of low-fire mode.

5.8 Thermal shock protection (TSS)

Interlocking



Note!

Functions *Cold start of plant* and *Thermal shock protection (TSS)* are interlocked. Only one function can be activated, but never both at the same time.

The controller comes with thermal shock protection (TSS) deactivated; it can be activated at the configuration level.



Reference!

See chapter 8.5 *Thermal shock protection (TSS)* rAFC.

Function

The function is automatically activated when the actual value drops below the adjustable limit value rAL (exceeds the adjustable limit value with the cooling controller). In that case, the setpoint is approached via a ramp function.

Gradient and slope of the ramp $rASL$ are adjustable. The setpoint ramp has a symmetrical tolerance band $tolP$. If, during the startup phase, the actual value leaves the tolerance band, the setpoint ramp is stopped until the actual value returns to a level within the tolerance band. The startup phase is ended when the setpoint of the ramp function reaches the final setpoint $SP1$.



Note!

When thermal shock protection (TSS) is active, the controller operates in low-fire operation. The response threshold (q) is active.

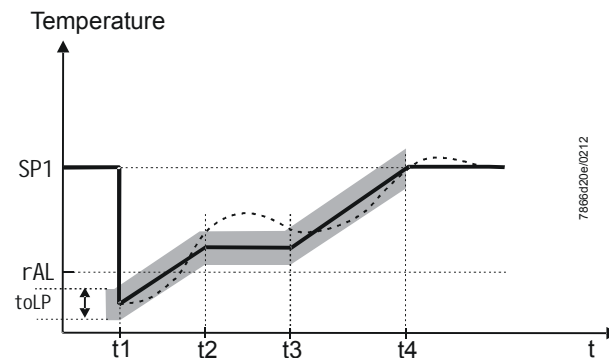

Figure 19: Thermal shock protection (TSS)

Key

- Setpoint (w)
- Actual value (x)

6 Operation

6.1 Meaning of display and buttons

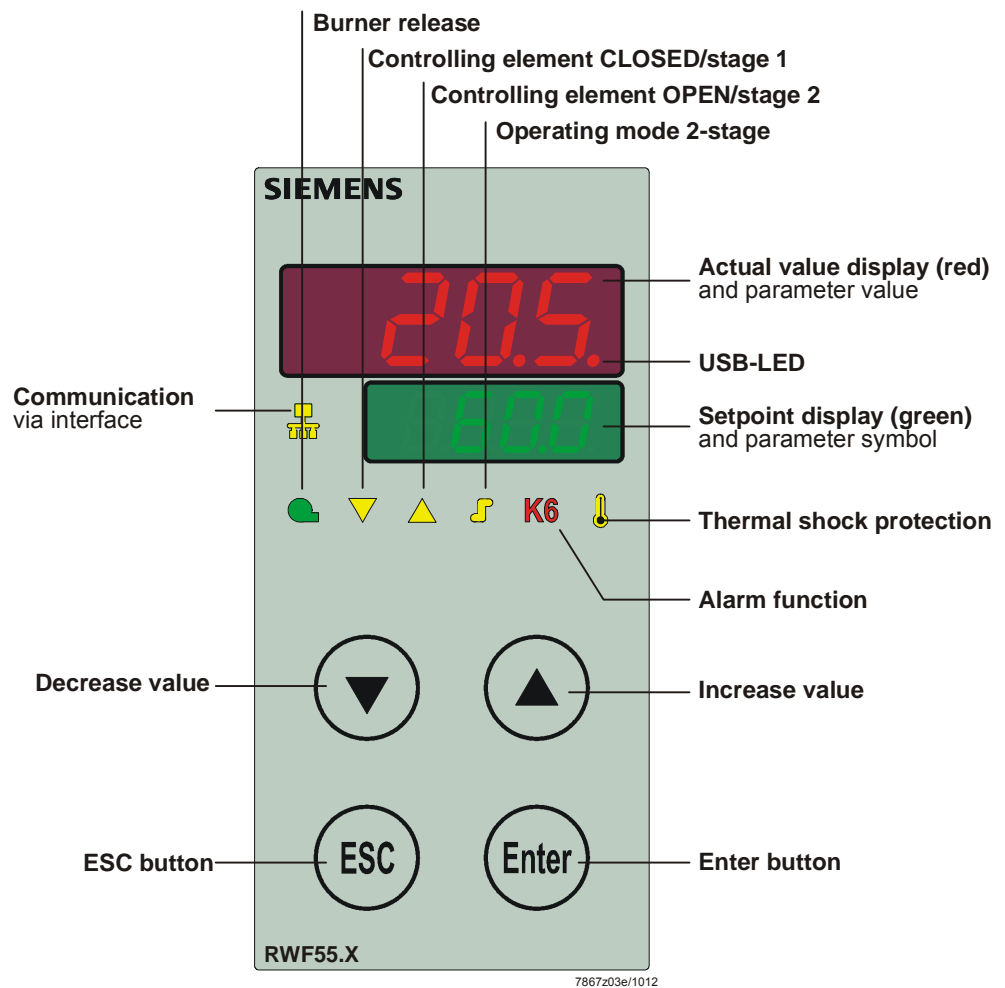

Figure 20: Meaning of display and buttons

Initialization

The two 7-segment displays (red and green) show hyphens and all LEDs light up for about 5 seconds.

Basic display

The upper display (red) shows the actual value.
The lower display (green) shows the setpoint.

⇒ Reference!
See chapter 8.9 *Display di SP.*

Parameter display

When entering parameters, the parameter symbol (green) and the set value (red) appear.

Self-setting function

The actual value is shown on the actual value display (red) and **tUNE** flashes on the setpoint display (green).

⇒ Reference!
See chapter 9.1 *Self-setting function in the high-fire operation.*

Flashing actual value display

The actual value display (red) shows **9999** flashing → Alarm message.

⇒ Reference!
See chapter 13 *What to do if ...*

Manual control

The setpoint display (green) shows **HAnd** flashing.

⇒ Reference!
See chapter 6.4 *Manual control of a modulating burner.*

6.2 Basic display

When switching power on, the displays show hyphens for about 5 seconds.

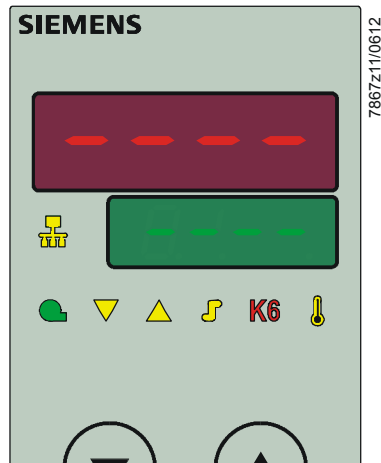

Figure 21: Display start

The state that follows is called *normal display*.

Default display is the actual value and the current setpoint.

Other values can be displayed via configuration level or via PC software ACS411.



Reference!

See chapter 8.9 *Display di SP*.

Manual control, self-setting, the user level, parameter level and configuration levels can be activated from here.

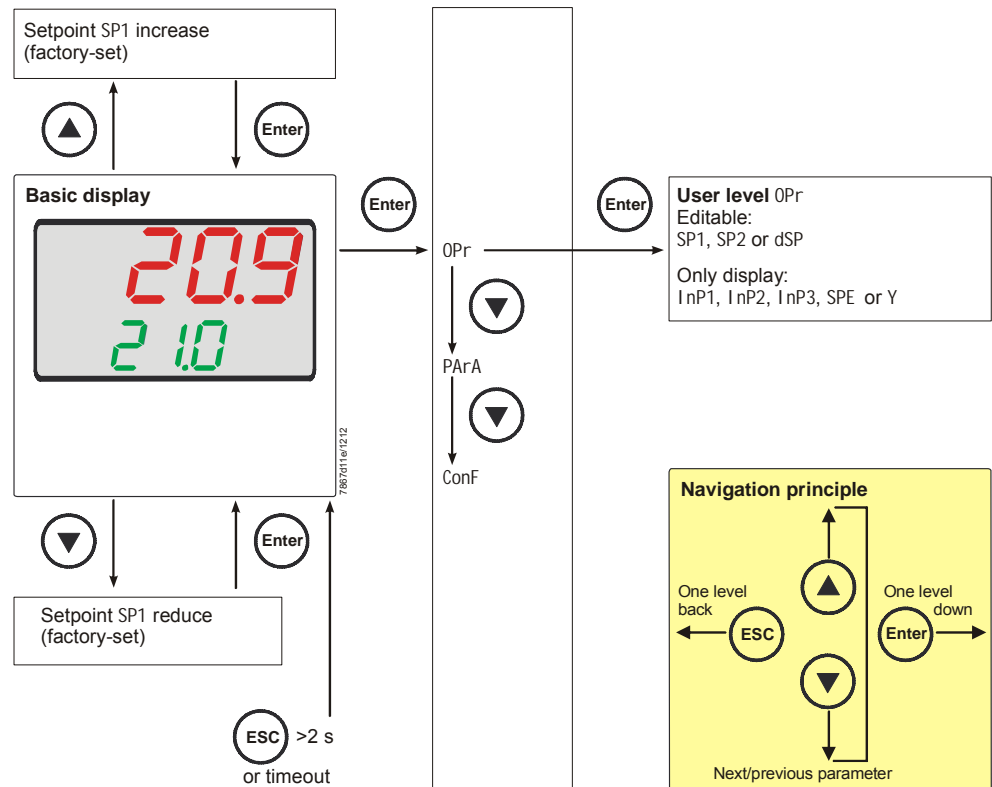

Figure 22: Basic display

6.3 User level

This level is started from the basic display.

Setpoints SP1, SP2 or dSP can be altered.





The values of the analog inputs I nP1, I nP2, I nP3 and SPE (external setpoint) and I nP3 (actual angular positioning between 0...100%) can be displayed.

Changing the setpoints

Changing SP1, SP2 or dSP.







- * From the basic display, press  so that 0Pr appears

SP1

- * Press  so that SP1 appears
- * Press  and SP1 flashes
- * Press  or  to adjust the required setpoint and press  to confirm







SP2

SP2 only appears if **setpoint changeover** is set (binary input bi n1 = 1).

- * From the basic display, press  so that 0Pr appears
- * Press  so that SP1 appears
- * Press  to change over to SP2
- * Press  and SP2 flashes
- * Press  or  to adjust the required setpoint and press  to confirm

dSP

dSP only appears if **setpoint shifting** is set (binary input bi n1 = 2).

- * From the basic display, press  so that 0Pr appears
- * Press  so that SP1 appears
- * Press  to change over to dSP
- * Press  and dSP flashes
- * Press  or  to adjust the required setpoint and press  to confirm

Timeout

Timeout after about 180 seconds.



Note!

If the setpoint is not stored, the basic display changes after the timeout tout and the former setpoint is maintained.

The value changes only within the permitted range.

6.4 Manual control, modulating burner





Note!

Manual control can only be activated if the thermostat function **energized** relay K1. If the thermostat function **deenergized** relay K1 during manual control, manual control is ended.

- * Press  for 5 seconds

HAnd appears on the lower display, alternating with the value for manual control (with continuous controller).

3-position controller

- * Open and close fuel-air ratio control by pressing  and 

Relay K2 opens the controlling element as long as  is kept depressed.

Relay K3 closes the controlling element as long as  is kept depressed.

The 2 yellow arrows indicate when relay K2 opens or relay K3 closes the controlling element.

Modulating controller

- * Change angular positioning by pressing  or 

- * Adopt flashing new angular positioning by pressing 

Per default, the analog output delivers the current angular positioning.

- * Return to automatic operation by keeping  depressed for 5 seconds



Note!

When activating manual control, angular positioning is set to 0 until another entry is made.

6.5 Manual control, 2-stage burner



Note!

Manual control can only be activated if the thermostat function **active** relay K1. If the thermostat function **inactive** relay K1 during manual control, manual control is ended.

- * Press  for 5 seconds
- * Press  briefly

Relay K2 / K3	Analog output A- / A+
Relay K2 is active Relay K3 is inactive	The analog output delivers the highest value (depending on setting DC 10 V or 20 mA)
Controlling element opens	

- * Or press  briefly

Relay K2 / K3	Analog output A- / A+
Relay K2 is inactive Relay K3 is active	The analog output delivers the lowest value (depending on setting DC 0 V, 4 mA, or 0 mA)
Controlling element closes	

- * Return to automatic operation by pressing  for 5 seconds

6.6 Starting the self-setting function

Start * Press ▲ + ▼ for 5 seconds

Cancel * Cancel with ▲ + ▼

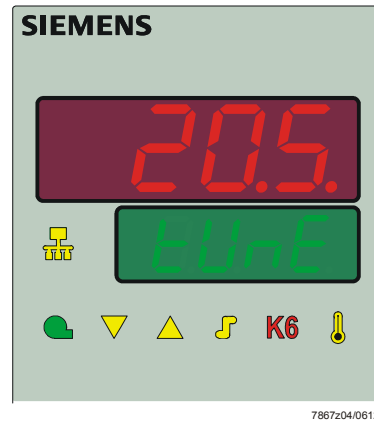

Figure 23: Display of self-setting function

When tUnE stops flashing, the self-setting function has been ended.

The parameters calculated by the controller are automatically adopted!



Note!

It is not possible to start tUnE in manual control or low-fire operation.

6.7 Display of software version

* Press  + 

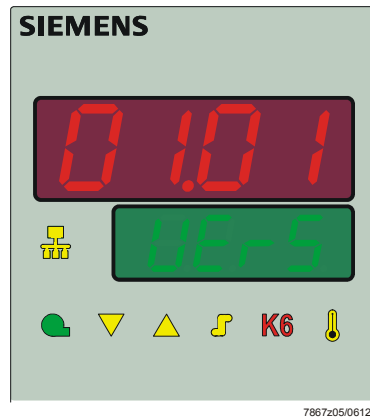

Figure 24: Display of software version

Segment test

* Press  +  again.



Figure 25: Display segment test

All display segments and LEDs light up; the actual value display (red) flashes for about 10 seconds.

7 Parameterization PArA

Here, set the parameters associated directly with the controller's adaptation to the controlled system after the plant has been put into operation.



Note!

The display of the individual parameters depends on the type of controller.

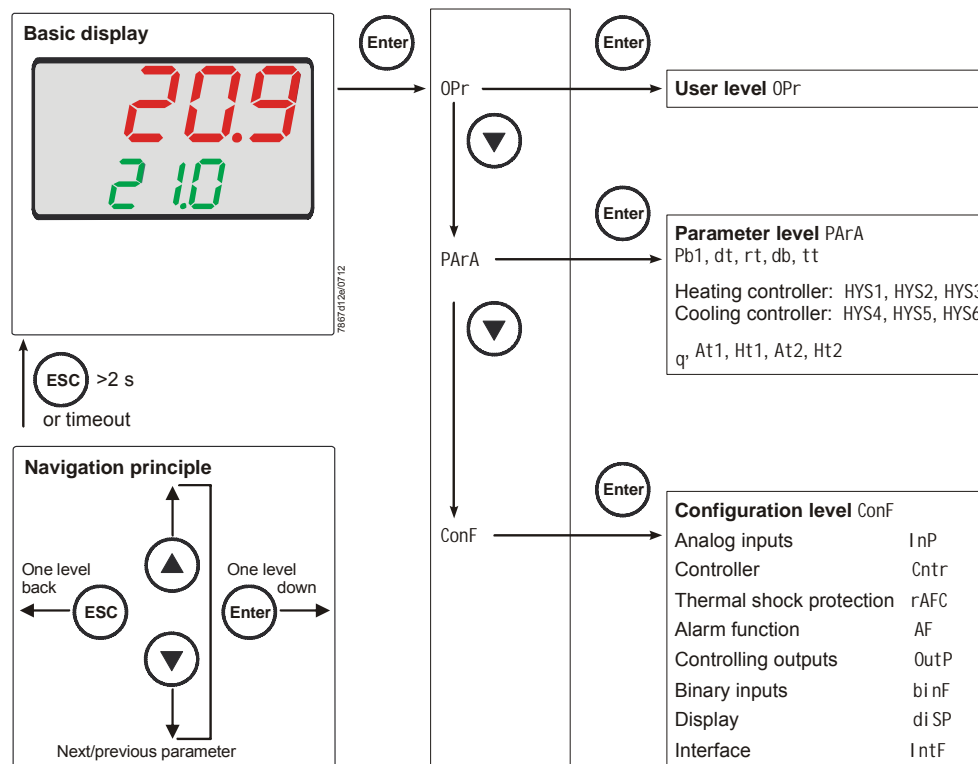

Figure 26: Parameterization

Access to this level can be locked.



Reference!

See chapter 8.9 *Display di SP*.

- * From the basic display, press **Enter** so that OPr appears
- * Press **▼** so that PArA appears
- * Press **Enter** so that the first parameter of the parameter level is displayed

Display of controller parameters

The parameters are shown on the lower setpoint display (green) and their values on the upper/actual value display (red).

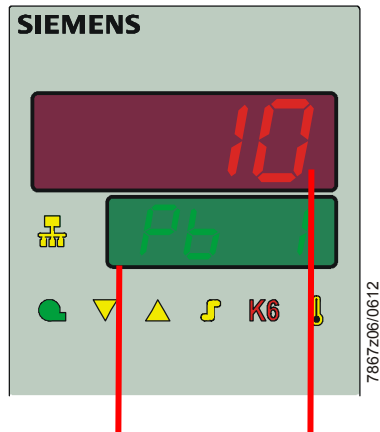

Parameter	Display	Value range	Factory setting	Remarks
Proportional band ¹	Pb1	1...9999 digit	10	Influences the controller's P-action
Derivative time	dt	0...9999 s	80	Influences the controller's D-action With dt = 0, the controller has no D-action
Integral action time	rt	0...9999 s	350	Influences the controller's I-action With rt = 0, the controller has no I-action
Dead band (neutral zone) ¹	db	0.0...999.9 digit	1	For 3-position output
Controlling element running time	tt	10...3000 s	15	Running time of the positioning valve for use with modulating controllers
Switch-on threshold Heating controller ¹	HYS1	-1999...0.0 digit	-5	⇒ Reference! See chapter 5.2 <i>High-fire operation</i>
Switch-off threshold stage II Heating controller ¹	HYS2	0.0...HYS3 digit	3	⇒ Reference! See chapter 5.2 <i>High-fire operation</i>
Switch-off threshold Heating controller ¹	HYS3	0.0...9999 digit	5	⇒ Reference! See chapter 5.2 <i>High-fire operation</i>
Switch-on threshold Cooling controller ¹	HYS4	0.0...9999 digit	5	⇒ Reference! See chapter 5.2 <i>High-fire operation</i>
Switch-off threshold stage II Cooling controller ¹	HYS5	HYS6...0.0 digit	-3	⇒ Reference! See chapter 5.2 <i>High-fire operation</i>
Switch-off threshold Cooling controller ¹	HYS6	-1999...0.0 digit	-5	⇒ Reference! See chapter 5.2 <i>High-fire operation</i>
Response threshold	q	0.0...999.9	0	⇒ Reference! See chapter 5.6 <i>Response threshold (q)</i>

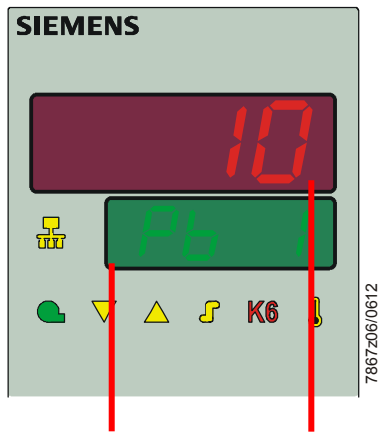

Parameter	Display	Value range	Factory setting	Remarks
Outside temperature Curve point 1 ¹	At1	-40...120	-10	⇒ Reference! See chapter 5.5 <i>Weather-compensated setpoint shifting</i>
Boiler temperature Curve point 1 ¹	Ht1	SPL...SPH	60	⇒ Reference! See chapter 5.5 <i>Weather-compensated setpoint shifting</i>
Outside temperature Curve point 2 ¹	At2	-40...120	20	⇒ Reference! See chapter 5.5 <i>Weather-compensated setpoint shifting</i>
Boiler temperature Curve point 2 ¹	Ht2	SPL...SPH	50	⇒ Reference! See chapter 5.5 <i>Weather-compensated setpoint shifting</i>

¹ Setting of decimal place has an impact on this parameter



Note!

When using the RWF55... as a modulating controller only, or as a modulating controller without the burner release function (1P, 1N), parameter HYS1 must be set to 0 and parameters HYS2 and HYS3 must be set to their **maximum** values.

Otherwise, for example, when using default parameter HYS1 (factory setting -5), the 3-position controller is only released when the control deviation reaches -5 K.

8 Configuration ConF

Here, the settings (e.g. acquisition of measured value or type of controller) required directly for commissioning a certain plant are made and, for this reason, there is no need to change them frequently.

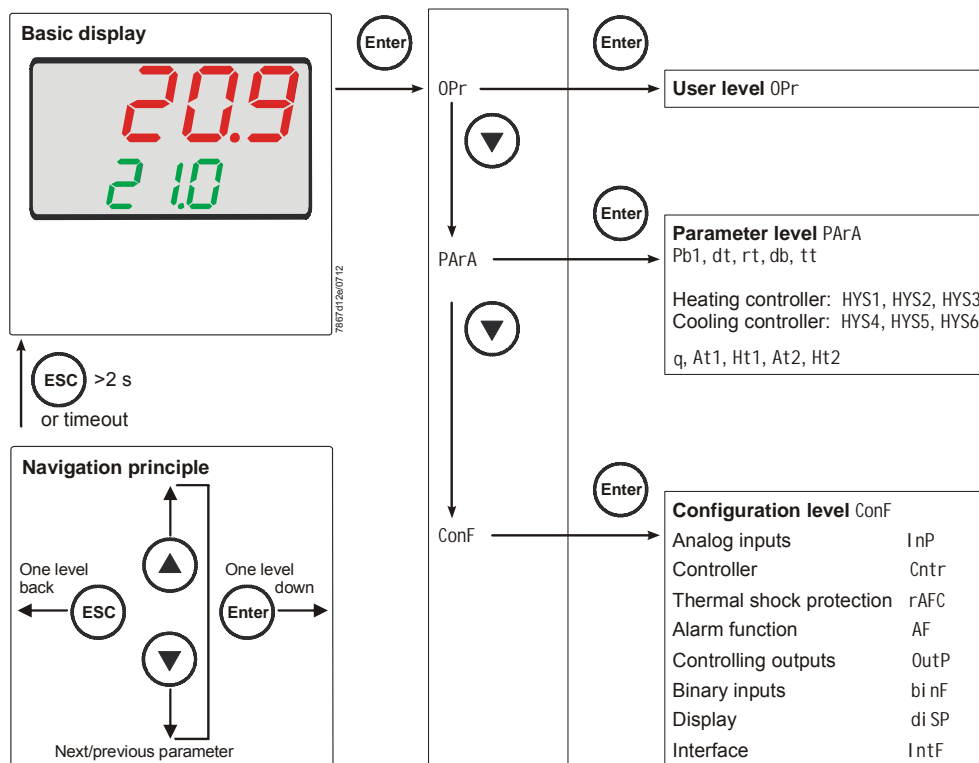

Figure 27: Configure

Access to this level can be locked.

⇒ **Reference!**
See chapter 8.9 *Display di SP*.

☞ **Note!**
The following tables show the default settings in columns *Value/selection* and *Description* in **bold** printing.

8.1 Analog input InP1

This input is used to acquire the actual value.

ConF → InP → InP1 →

Parameter	Value/ selection	Description									
Sensor type SEn1 Sensor type	1 2 3 4 5 6 7 8 9 10 11 12 13 14 15 16 17 18 19	Resistance thermometer Pt100, 3-wire Resistance thermometer Pt100, 2-wire Resistance thermometer Pt1000, 3-wire Resistance thermometer Pt1000, 2-wire Resistance thermometer LG-Ni1000, 3-wire Resistance thermometer LG-Ni1000, 2-wire 0...135 Ohm Cu-CuNi T Fe-CuNi J NiCr-Ni K NiCrSi-NiSi N Pt10Rh-Pt S Pt13Rh-Pt R Pt30Rh-Pt6Rh B 0...20 mA 4...20 mA DC 0...10 V DC 0...5 V DC 1...5 V									
Correction of measured value OFF1 Offset	-1999... 0... +9999	Using the measured value correction (offset), a measured value can be corrected to a certain degree, either up or down Example: <table> <thead> <tr> <th>Measured value</th> <th>Offset</th> <th>Displayed values</th> </tr> </thead> <tbody> <tr> <td>294.7</td> <td>+0.3</td> <td>295.0</td> </tr> <tr> <td>295.3</td> <td>-0.3</td> <td>295.0</td> </tr> </tbody> </table>	Measured value	Offset	Displayed values	294.7	+0.3	295.0	295.3	-0.3	295.0
Measured value	Offset	Displayed values									
294.7	+0.3	295.0									
295.3	-0.3	295.0									
 Caution! Measured value correction: To make the calculation, the controller uses the corrected value (displayed value). This value does not represent the value acquired at the point of measurement. If the measured value correction function is used incorrectly (e.g., overcompensation of measured values → measurement error only present temporarily), this may lead to undesirable plant states.											
Start of display SCL1 Scale low level	-1999... 0... +9999	In the case of a measuring transducer with standard signal, the physical signal is assigned a display value here Example: 0...20 mA = 0...1500 °C									
End of display SCH1 Scale high level	-1999... 100... +9999	The range of the physical signal can be crossed by 20%, either up or down, without getting a signal informing about the crossing									

Parameter	Value/ selection	Description
Filter time constant dF1 Digital filter	0.0... 0.6... 100.0...	<p>Is used to adapt the digital 2nd order input filter (time in s; 0 s = filter off)</p> <p>If the input signal changes abruptly, about 26% of the change are captured after a time corresponding to the filter time constant dF (2 x dF: approx. 59%; 5 x dF: approx. 96%)</p> <p>When the filter time constant is great:</p> <ul style="list-style-type: none"> - Great attenuation of interference signals - Slow response of actual value display to changes of the actual value - Low limit frequency (low-pass filter)
Temperature unit Unit Temperature unit	1 2	<p>Degrees Celsius</p> <p>Degrees Fahrenheit</p> <p>Unit of temperatures</p>

8.2 Analog input InP2

This input can be used to specify an external setpoint or carry out setpoint shifting.

ConF → InP → InP2 →

Parameter	Value/ selection	Description									
Function FnC2	0 1 2 3	No function External setpoint (display SPE) Setpoint shifting (display dSP) Angular positioning feedback									
Sensor type SEn2 Sensor type	1 2 3 4 5 6	0...20 mA 4...20 mA 0...10 V 0...5 V 1...5 V Resistance teletransmitter									
Correction of measured value OFF2 Offset	-1999... 0... +9999	Using the measured value correction function (offset), a measured value can be corrected by a certain amount, either up or down. Example: <table border="0"> <tr> <td>Measurement value</td> <td>Offset</td> <td>Display value</td> </tr> <tr> <td>294.7</td> <td>+0.3</td> <td>295.0</td> </tr> <tr> <td>295.3</td> <td>-0.3</td> <td>295.0</td> </tr> </table>	Measurement value	Offset	Display value	294.7	+0.3	295.0	295.3	-0.3	295.0
Measurement value	Offset	Display value									
294.7	+0.3	295.0									
295.3	-0.3	295.0									
 Caution! Measured value correction: To make the calculation, the controller uses the corrected value (displayed value). This value does not represent the value acquired at the point of measurement. If the measured value correction function is used incorrectly (e.g., overcompensation of measured values → measurement error only present temporarily), this may lead to undesirable plant states.											
Start of display SCL2 Scale low level	-1999... 0... +9999	In the case of a measuring transducer with standard signal, the physical signal is assigned a display value here. Example: 0...20 mA = 0...1500 °C									
End of display SCH2 Scale high level	-1999... 100... +9999	The physical signal range can be undershot/exceeded by 20% without a measuring range overshoot/undershoot signal being issued.									
Filter time constant dF2 Digital filter	0.0... 2... 100.0...	Is used to adapt the digital 2nd order input filter (time in s; 0 s = filter off). If the input signal changes abruptly, about 26% of the change is captured after a time corresponding to the filter time constant dF (2 x dF: approx. 59%; 5 x dF: approx. 96%). If the filter time constant is large: <ul style="list-style-type: none"> - High attenuation of interference signals - Slow response of actual value display to changes in the actual value - Low limit frequency (low-pass filter) 									

8.3 Analog input InP3

This input is used to acquire the outside temperature.



ConF → InP → InP3 →

Parameter	Value/ selection	Description									
Sensor type SEn3 Sensor type	0 1 2	Switched-off Resistance thermometer Pt1000 in 2-wire circuit Resistance thermometer LG-Ni1000 in 2-wire circuit									
Function FnC3	0 1	No function Weather-compensated setpoint									
Correction of measured value OFF3 Offset	-1999... 0... +9999	Using the measured value correction function (offset), a measured value can be corrected by a certain amount, either up or down. Example: <table border="0"> <tr> <td>Measurement value</td> <td>Offset</td> <td>Display value</td> </tr> <tr> <td>294.7</td> <td>+0.3</td> <td>295.0</td> </tr> <tr> <td>295.3</td> <td>-0.3</td> <td>295.0</td> </tr> </table>	Measurement value	Offset	Display value	294.7	+0.3	295.0	295.3	-0.3	295.0
Measurement value	Offset	Display value									
294.7	+0.3	295.0									
295.3	-0.3	295.0									
	<p>Caution! Measured value correction: To make the calculation, the controller uses the corrected value (displayed value). This value does not represent the value acquired at the point of measurement. If the measured value correction function is used incorrectly (e.g., overcompensation of measured values → measurement error only present temporarily), this may lead to undesirable plant states.</p>										
Filter time constant dF3 Digital filter	0.0... 1278... 1500.0...	Is used to adapt the digital 2nd order input filter (time in s; 0 s = filter off). If the input signal changes abruptly, about 26% of the change is captured after a time corresponding to the filter time constant dF (2 x dF: approx. 59%; 5 x dF: approx. 96%). If the filter time constant is large: - High attenuation of interference signals - Slow response of actual value display to changes in the actual value - Low limit frequency (low-pass filter)									

8.4 Controller Cntr

Here, the type of controller, operating action, setpoint limits and presettings for self-optimization are selected.

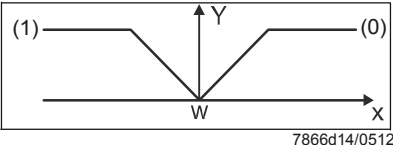

ConF → Cntr →

Parameter	Value/ selection	Description
Controller type CtYP Controller type	1 2	3-position controller Modulating controller
Operating action CACt Control direction	0 1	Cooling controller Heating controller  <p style="text-align: right; font-size: small;">7866d14/0512</p> <p>(0) = cooling controller: The controller's angular positioning (Y) is >0 when the actual value (x) lies above the setpoint (w)</p> <p>(1) = heating controller: The controller's angular positioning (Y) is >0 when the actual value (x) lies below the setpoint (w)</p>
Setpoint limitation start SPL Setpoint limitation low	-1999... 0... +9999	Setpoint limitation prevents values from being entered outside the defined range.
Setpoint limitation end SPH Setpoint limitation high	-1999... +100... +9999	The setpoint limits are not active in the case of predefining setpoints via the interface. In the case of an external setpoint with correction, the correction value is limited to SPL / SPH.
Self-optimization	0 1	Free Locked Self-optimization can only be disabled or enabled via the ACS411 setup program If disabled via ACS411 PC software, self-optimization cannot be started via the controller's buttons Setting in the ACS411 setup program → Controller → Self-optimization Self-optimization is also disabled when the parameter level is locked
Lower working range limit oLLo Lower operation range limit	-1999... +9999	 Note! If the setpoint with the respective hysteresis exceeds the upper working range limit, the switch-on threshold is substituted by the working range limit.
Upper working range limit oLHi Upper working range limit	-1999... +9999	 Note! If the setpoint with the respective hysteresis drops below the lower working range limit, the switch-off threshold is substituted by the working range limit.

8.5 Thermal shock protection (TSS)rAFC

The RWF55... can be operated as a fixed value controller with or without ramp function.

ConF → rAFC →

Parameter	Value/ selection	Description
Function FnCt Function	0 1 2	Switched off Gradient Kelvin/minute Gradient Kelvin/hour  <div style="background-color: #ffff00; padding: 5px;"> <p>Note! With FnCt = 1 or 2, <i>Thermal shock protection (TSS)</i> is automatically activated as soon as the actual value drops below the adjustable absolute limit value rAL (heating controller) or exceeds it (cooling controller).</p> </div>
Ramp slope rASL Ramp slope	0.0... 999.9	Slope of ramp slope (only with functions 1 and 2)
Tolerance band ramp toLP Tolerance band ramp	2 x HYS1 = 10...9999	Width of tolerance band (in K) about the setpoint (only with function 1 and 2) Heating controller: Smallest possible factory setting: 2 x HYS1 = 10 K To monitor the actual value in connection with thermal shock protection (TSS), a tolerance band can be laid about the setpoint curve. If the limit values are crossed, the ramp is stopped.  <div style="background-color: #ffff00; padding: 5px;"> <p>Reference! See chapter 5.8 <i>Thermal shock protection (TSS)</i>.</p> </div> Cooling controller: Smallest possible factory setting: 2 x HYS4 = 10 K
	Note! In the event of a faulty sensor or manual control, the ramp function is stopped. The outputs behave the same way they do when the measuring range is crossed (configurable). Functions <i>Cold start of plant</i> and <i>Thermal shock protection (TSS)</i> are interlocked. Only one function can be activated, but never both at the same time.	
Limit value rAL Ramp limit	0...250	Heating controller: If the actual value lies below this limit value, the setpoint is approached in the form of a ramp until final setpoint SP1 is reached. Cooling controller: If the actual value lies above this limit value, the setpoint is approached in the form of a ramp until final setpoint SP1 is reached.

8.6 Alarm function AF

ConF → AF →

The alarm function can be used to monitor the analog inputs. If the limit value is exceeded, multifunctional relay K6 is activated (depending on the switching characteristic). The alarm function can have different switching functions (**Ik1** to **Ik8**) and can be set to a deviation from the active setpoint or to a fixed limit value.

Limit value AL relative to setpoint (w)

In the case of alarm functions **Ik1** to **Ik6**, the actual value I_{nP1} is monitored in relation to a limit value AL that has to be set (with the absolute value dependent on the setpoint (w)).

Ik1

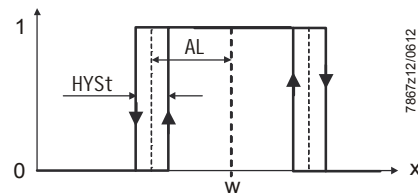

Ik2

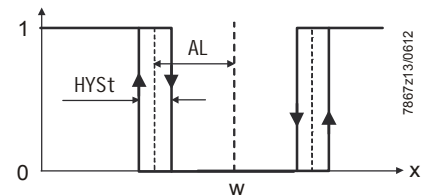

Ik3

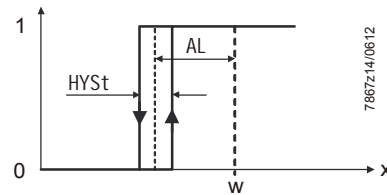

Ik4

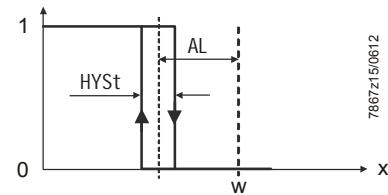

Ik5

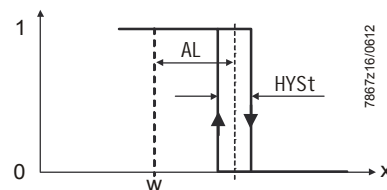

Ik6

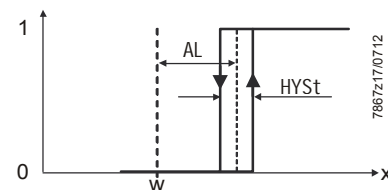
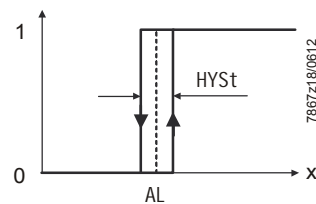

Figure 28: Alarm function Ik1...Ik6

Fixed limit value AL

In the case of alarm functions **Ik7** and **Ik8**, all analog inputs I_{nP1} ... I_{nP3} can be monitored in relation to a fixed limit value AL that has to be set.

Ik7



Ik8

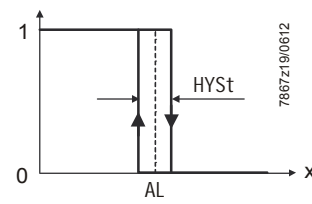

Figure 29: Alarm function Ik7 and Ik8

Parameter	Value/ selection	Description
Function FnCt Function	0 1 2 3 4 5 6 7 8 9 10 11 12	Without function Ik1 monitored input I nP1 Ik2 monitored input I nP1 Ik3 monitored input I nP1 Ik4 monitored input I nP1 Ik5 monitored input I nP1 Ik6 monitored input I nP1 Ik7 monitored input I nP1 Ik8 monitored input I nP1 Ik7 monitored input I nP2 Ik8 monitored input I nP2 Ik7 monitored input I nP3 Ik8 monitored input I nP3
Limit value AL Alarm value	-1999... 0... +9999	Limit value or deviation from setpoint to be monitored (see alarm functions Ik1 to Ik8 : limit value AL). Limit value range for Ik1 and Ik2 : 0...9999
Switching difference HYSt Hysteresis	0... 1... 9999	Switching difference in relation to limit value (see alarm functions Ik1 to Ik8 : hysteresis HYSt).
Response by Out of Range ACrA Response by out of range	0 1	Switching state in the case of measuring range overshoot or undershoot (Out of Range). Switched-off ON

8.7 Control outputs OutP

For fuel-air ratio control purposes, the RWF55 has the binary outputs (K2, K3) and the analog output (A+, A-).

The burner is released via relay K1.

The switching states of relay K1 *Burner release* (LED green), relay K2 *Controlling element OPEN*, and relay K3 *Controlling element CLOSE* (yellow LED arrows) are indicated on the controller front.

Binary outputs

The binary outputs of the RWF55 offer no setting choices.

Analog output

The RWF55 has an analog output.

The analog output offers the following setting choices:

ConF → OutP →

Parameter	Value/ selection	Description
Function FnCt Function	0 1 2 3 4	No function Input I nP1 is delivered Input I nP2 is delivered Input I nP3 is delivered Controller's angular positioning is delivered (modulating controller)
Signal type Si Gn Type of signal	0 1 2	0...20 mA 4...20 mA DC 0...10 V Physical output signal
Value when out of range rOut Value when out of range	0...101	Signal (in percent) when measuring range is crossed 101 = last output signal
Zero point OPnt Zero point	-1999... 0... +9999	A value range (in percent) of the output variable is assigned to a physical output signal.
End value End End value	-1999... 100... +9999	 Note! To avoid distorting the controller results, the <i>end value</i> and <i>zero point</i> values – in combination with Function 4: <i>Controller's angular positioning is delivered</i> – should not be changed.

8.8 Binary input bi nF

This setting decides on the use of the binary inputs.

⇒ Reference!
See chapter 5.4 *Preselected setpoint*

ConF → bi nF →

Parameter	Value/ selection	Description
Binary inputs	0	No function
bi n1 Binary input 1	1	Setpoint changeover
	2	Setpoint shift
	3	Alarm input
bi n2 Binary input 2	4	Changeover of operating mode
		Burner modulating: Contacts D2 and DG open
		Burner 2-stage: Contacts D2 and DG closed

8.9 Display di SP

By configuring the position of the decimal point and automatic changeover (timer), both LED indications can be adapted to the respective requirements. Timeout tout for operation and the locking of levels can be configured as well.

ConF → di SP →

Parameter	Value/ selection	Description
Upper display di SU Upper display	0 1 2 3 4 6 7	Display value for upper display Switched off Analog input I nP1 Analog input I nP2 Analog input I nP3 Controller's angular positioning Setpoint End value with thermal shock protection
Lower display di SL Lower display	0 1 2 3 4 6 7	Display value for lower display Switched off Analog input I nP1 Analog input I nP2 Analog input I nP3 Controller's angular positioning Setpoint End value with thermal shock protection
Timeout tout	0... 180... 255	Time (s) on completion of which the controller returns automatically to the basic display, if no button is pressed
Decimal point dECP Decimal point	0 1 2	No decimal place One decimal place Two decimal places If the value to be displayed cannot be shown with the programmed decimal point, the number of decimal places is automatically reduced. If the measured value drops again, the number of decimal places is increased until the programmed value is reached
Locking of levels CodE	0 1 2 3	No locking Locking of configuration level Locking of parameter level Locking of keyboard

8.10 Interface IntF

The controller can be integrated into a data network using an optional RS-485 interface or an optional Profibus DP interface.

ConF → IntF →

Parameter	Value/ selection	Description
Baud rate bdrt Baud rate	0 1 2 3	4800 Baud 9600 Baud 19200 Baud 38400 Baud
Device address Modbus Adr Device address	0... 1... 254	Address in the data network
Device address Profibus dP Device address	0... 125	Only RWF55.6
Remote Detection Timer dtt Remote detection timer	0... 30... 7200 s	0 = Switched-off



Note!

If communication is taking place via the setup interface, the other interfaces are inactive.

9 Self-setting function

9.1 Self-setting function in high-fire operation



Note!

tUnE is only possible in high-fire operation, in *modulating burner* mode.

Self-setting function tUnE is a proper software function unit integrated in the controller. In *modulating* mode, tUnE tests in high-fire operation the response of the controlled system to angular positioning steps according to a special procedure. A complex control algorithm uses the response of the controlled system (actual value) to calculate and automatically store the control parameters for a PID or PI controller (set $dt = 0!$). The tUnE procedure can be repeated any number of times.

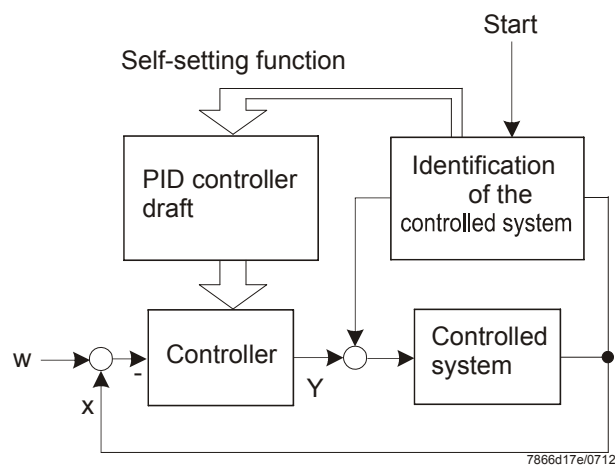

Figure 30: Self-setting function in high-fire operation

2 procedures

The **tUnE** function uses 2 different methods that are automatically selected depending on the dynamic state of the actual value and the deviation from the setpoint at startup. **tUnE** can be started from within any dynamic actual value sequence.

If there is a **great difference between actual value and setpoint** when **tUnE** is activated, a switching line is established about which the controlled variable performs forced oscillations during the self-setting process. The switching line is set to such a level that the actual value should not exceed the setpoint.

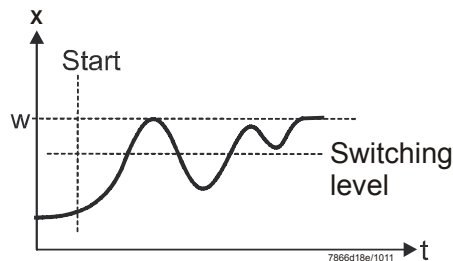

Figure 31: Great difference between actual value and setpoint

With a **small deviation** between setpoint and actual value (after the controlled system has settled, for instance), forced oscillation about the setpoint is performed.

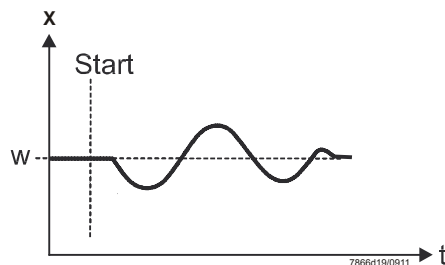

Figure 32: Small control deviation

The data of the controlled system recorded for the forced oscillations are used to calculate the controller parameters **rt**, **dt**, **Pb1** and a filter time constant **dF1** for actual value filtering that is optimized for this controlled system.

Conditions

- High-fire operation in *modulating burner* mode
- The thermostat function (relay K1) must be constantly activated; otherwise **tUnE** will be canceled and no optimized controller parameters will be adopted
- The above mentioned actual value oscillations during the self-setting process must not exceed the upper threshold of the thermostat function (increase if necessary, and lower the setpoint)



Note!

A successfully started *Self-setting* function is automatically aborted after 2 hours. This could occur in the case of a controlled system that responds slowly, for example, where, even after 2 hours, the described procedures cannot be successfully completed.

9.2 Checking the controller parameters

Optimum adjustment of the controller to the controlled system can be checked by recording a startup sequence with the control loop closed. The following diagrams indicate possible incorrect adjustments, and their correction.

Example

The response to a setpoint change is shown here for a 3rd order controlled system for a PID controller. The method used for adjusting the controller parameters can, however, also be applied to other controlled systems. A suitable value for dt is $rt/4$.

Pb too small

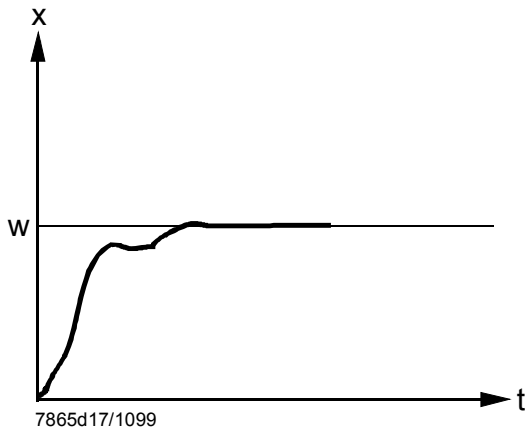

7865d17/1099
Figure 33: Pb too small

Pb too large

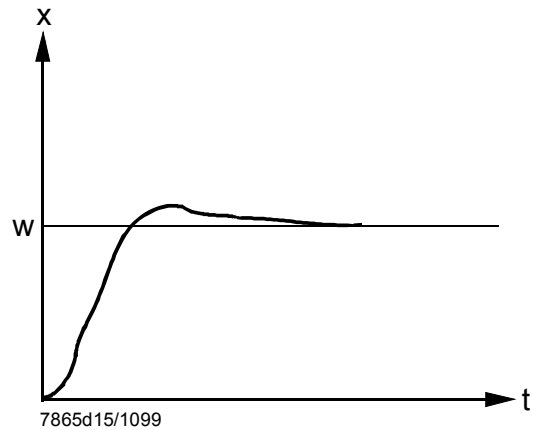

7865d15/1099
Figure 34: Pb too large

rt, dt too small

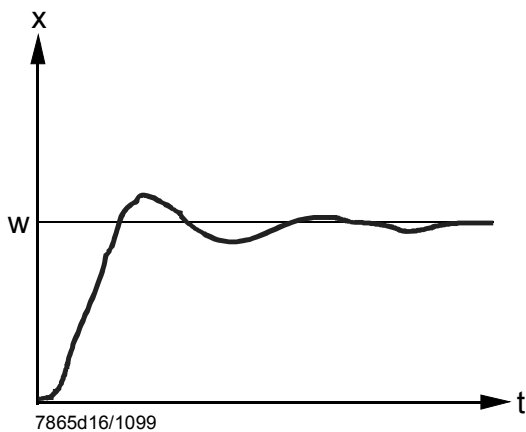

7865d16/1099
Figure 35: rt, dt too small

rt, dt too large

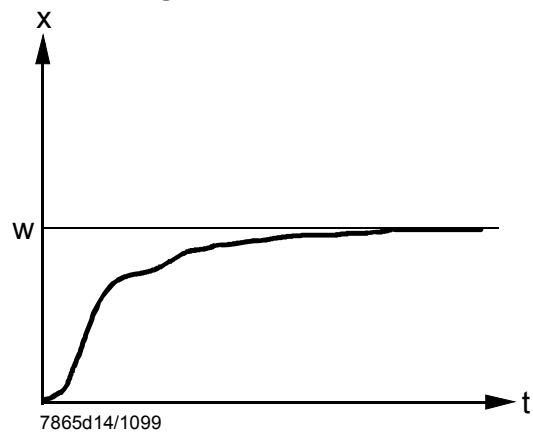

7865d14/1099
Figure 36: rt, dt too large

Optimum adjustment

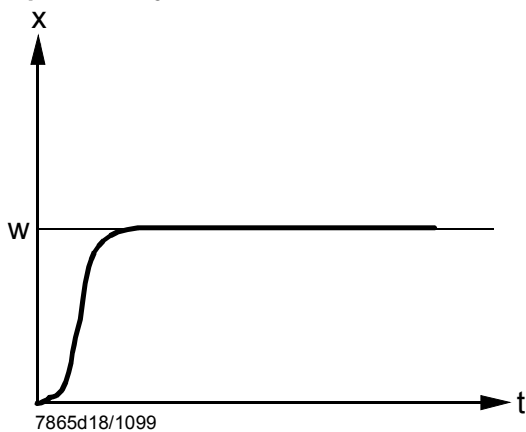

7865d18/1099
Figure 37: Optimum adjustment

10 PC software ACS411

PC software ACS411 is an operating module for use with the RWF55... universal controller and designed for the following basic tasks:

- Visualization of system state covering the following data:
 - Parameters
 - Process data
 - Configuration and parameterization of the controller (individual parameters)
 - Saving and restoration of parameter sets

A USB cable can be used to establish the connection between PC (USB plug type A, 4 pins) and RWF55 (USB plug type Mini B, 5 pins).



Note!
The cable must be purchased on site.

10.1 Safety notes



Caution!
PC software ACS411 is a convenient tool for use by qualified personnel, designed to commission and optimize the universal controller. Since the required actions and settings are safety-related, the user has a special obligation to exercise due care. Although specific technical measures have been taken to prevent incorrect entry of data and wrong parameter values, the user must check the correct function of the plant in a conventional way both during and after commissioning and – if required – ensure manual shutdown.

10.2 Setting the correct system parameters



Caution!
It should be noted that the characteristics of the universal controller are determined primarily by the parameter settings made, rather than by the type of unit. It is especially the OEM which is responsible for making certain that the controller's parameter settings are in compliance with the standards covering the respective application or type of plant. Responsibility for the parameter settings is assumed by the person who, in accordance with the access rights, makes or has made changes at the respective setting level. The detailed descriptions and safety notes given in the User Manual on the system components must also be observed.

10.3 Changing the parameters or the plant's configuration



Caution!
After changing parameters, all parameters must be checked via the unit's display to ensure they are correctly set – without making use of the PC software ACS411.

10.4 Place of installation



Caution!

PC software ACS411 is designed for use on site, that is, within viewing and hearing distance of the respective combustion plant. This means that remote control is not permitted.

10.5 License and liability regulations



Note!

For ENDUSER LICENSE AGREEMENT for PC software ACS411, refer to program menu item *Info* → *Software documentation*.

IMPORTANT – PLEASE READ CAREFULLY!

10.6 Procurement of PC software ACS411

For ordering the ACS411 software and updates, please contact your supplier or heating engineer.

10.7 Languages

PC software ACS411 is available in English and German. To select the language you require, go to program menu item *File* → *Default settings* → *Program language* (ACS411 setup program must be restarted).

10.8 Operating systems : Operating

- Windows 2000 SP4
- Windows 7 - 32 bit
- Windows 7 - 64 bit
- Windows VISTA
- Windows XP

10.9 Prerequisites for hardware

- Free hard disk memory: 300 MB
- RAM: 512 MB

10.10 Installation



Note!

First, install PC software ACS411; then, connect the controller. If not observed, an error message is delivered.

PC software ACS411 is supplied on a CD.

- * Insert CD in the CD or DVD drive.
Setup starts automatically.
- * Follow the instructions appearing on the screen.
- * Connect PC and controller via the USB cable.
New hardware is identified and USB driver installed.
This may take a few minutes.
- * Follow further instructions given on the screen and wait until the installation is successfully completed.

10.11 Others

10.11.1 Use of USB port : Use of

Use

The USB port is intended for temporary use to make the parameter settings, the configuration and for work in connection with commissioning.
When using the USB port, the controller can be securely operated, tested and set with no need for using the mains cable.

10.11.2 Powering the controller via the USB port : Powering the controller

via the port

Using the HUB: Using the

If the controller shall be powered via the USB port, a HUB with power supply is required, capable of delivering at least 500 mA at every outlet.

Switching off: Switching off

When supplying power via the USB port, relays and analog output are deenergized to reduce power consumption.



Note!

Check to ensure that power supply to the measuring converter (G+ and G-) is not connected. This increases power usage via the USB port as well.

Measuring accuracy:

The measuring accuracy specified in chapter 12 *Technical data* does not apply when powering the controller via the USB port.

11 Modbus interface

The tables that follow in this chapter specify the addresses of the readable and writable words that the customer is able to access. The customer may read and/or write the values using SCADA programs, PLCs, or similar.

The entries under *Access* have the following meanings:

R/O Read **O**nly, value can only be read
R/W Read/**W**rite, value can be read and written

The number of characters specified under *Data type* in the case of character strings includes the final **\0**.

Example:

Char10 means that the text is up to **9** characters long. The final **\0** character is then added to this.

11.1 User level

Address	Access	Data type	Signal reference	Parameter
0x0000	R/O	Float	X1	Analog input I nP1
0x0002	R/O	Float	X2	Analog input I nP2
0x0004	R/O	Float	X3	Analog input I nP3
0x0006	R/O	Float	WR	Actual setpoint
0x0008	R/W	Float	SP1	Setpoint 1
0x000A	R/W	Float	SP2 (= dSP)	Setpoint 2
0x1035	R/O	Float	---	Analog input I nP3 (unfiltered)
0x1043	R/O	Float	---	Actual angular positioning
0x1058	R/O	Word	B1	Burner alarm

11.2 Parameter level

Address	Access	Data type	Signal reference	Parameter
0x3000	R/W	Float	Pb1	Proportional range 1
0x3004	R/W	Float	dt	Derivative action time
0x3006	R/W	Float	rt	Integral action time
0x300C	R/W	Float	db	Dead band
0x3012	R/W	Word	tt	Controlling element running time
0x3016	R/W	Float	HYS1	Switch-on threshold
0x3018	R/W	Float	HYS2	Switch-off threshold down
0x301A	R/W	Float	HYS3	Switch-off threshold up
0x301C	R/W	Float	HYS4	Switch-on threshold (cooling)
0x301E	R/W	Float	HYS5	Switch-off threshold down (cooling)
0x3020	R/W	Float	HYS6	Switch-off threshold up (cooling)
0x3022	R/W	Float	q	Reaction threshold
0x3080	R/W	Float	At1	Outside temperature 1
0x3082	R/W	Float	Ht1	Boiler temperature 1
0x3084	R/W	Float	At2	Outside temperature 2
0x3086	R/W	Float	Ht2	Boiler temperature 2

11.3 Configuration level

Address	Access	Data type	Signal reference	Parameter
0x3426	R/W	Float	SCL1	Start of display input 1
0x3428	R/W	Float	SCH1	End of display input 1
0x3432	R/W	Float	SCL2	Start value input 2
0x3434	R/W	Float	SCH2	End value input 2
0x3486	R/W	Float	SPL	Start of setpoint limitation
0x3488	R/W	Float	SPH	End of setpoint limitation
0x342A	R/W	Float	OFFS1	Offset input E1
0x3436	R/W	Float	OFFS2	Offset input E2
0x343A	R/W	Float	OFFS3	Offset input E3
0x1063	R/W	Word	FnCt	Ramp function
0x1065	R/W	Float	rASL	Ramp slope
0x1067	R/W	Float	tolP	Tolerance band ramp
0x1069	R/W	Float	rAL	Limit value
0x1075	R/W	Float	dtT	Remote Detection Timer
0x1077	R/W	Float	dF1	Filter constant input 1
0x1079	R/W	Float	dF2	Filter constant input 2
0x107B	R/W	Float	dF3	Filter constant input 3
0x107D	R/O	Float	oLlo	Lower working range limit
0x107F	R/O	Float	oLHi	Upper working range limit
0x106D	R/W	Word	FnCt	Alarm relay function
0x106F	R/W	Float	AL	Alarm relay limit value (limit value alarm)
0x1071	R/W	Float	HYSr	Alarm relay hysteresis

11.4 Remote operation

Address	Access	Data type	Signal reference	Parameter
0x0500	R/W	Word	REM	Activation remote operation *
0x0501	R/W	Word	rOFF	Controller OFF in remote setpoint **
0x0502	R/W	Float	rHYS1	Switch-on threshold remote
0x0504	R/W	Float	rHYS2	Switch-off threshold down remote
0x0506	R/W	Float	rHYS3	Switch-off threshold up remote
0x0508	R/W	Float	SPr	Setpoint remote
0x050A	R/W	Word	RK1	Burner release remote operation
0x050B	R/W	Word	RK2	Relay K2 remote operation
0x050C	R/W	Word	RK3	Relay K3 remote operation
0x050D	R/W	Word	RK6	Relay K6 remote operation
0x050E	R/W	Word	rStEP	Step-by-step control remote operation
0x050F	R/W	Float	rY	Angular positioning output remote operation
0x0511	R/W	Float	rHYS4	Switch-on threshold remote (cooling)
0x0513	R/W	Float	rHYS5	Switch-off threshold down remote (cooling)
0x0515	R/W	Float	rHYS6	Switch-off threshold up remote (cooling)

Legend

* = Local

** = Controller OFF

11.5 Device data

Address	Access	Data type	Signal reference	Parameter
0x8000	R/O	Char12	---	Software version
0x8006	R/O	Char14	---	VdN number

11.6 Device state

Address	Access	Data type	Signal reference	Parameter
0x0200	R/O	Word	---	Outputs and states
			Bit 0	Output 1
			Bit 1	Output 3
			Bit 2	Output 2
			Bit 3	Output 4
			Bit 8	Hysteresis limitation
			Bit 9	Control system
			Bit 10	Self-optimization
			Bit 11	Second setpoint
			Bit 12	Measuring range overshoot I nP1
			Bit 13	Measuring range overshoot I nP2
			Bit 14	Measuring range overshoot I nP3
			Bit 15	Calibration mode
0x0201	R/O	Word	---	Binary signals and hardware detection
			Bit 0	Operation mode 2-stage
			Bit 1	Manual mode
			Bit 2	Binary input D1
			Bit 3	Binary input D2
			Bit 4	Thermostat function
			Bit 5	First controller output
			Bit 6	Second controller output
			Bit 7	Alarm relay
			Bit 13	Analog output available
			Bit 14	Interface available

12 Profibus-DP interface

12.1 RS-485 Technology transfer

Transmission is carried out in accordance with the RS-485 standard. This covers all areas in which high transmission speeds and simple, inexpensive installation technology are required. A twisted, shielded copper cable with a wire pair is used for this purpose.

The bus structure enables non-reacting coupling and decoupling of stations or gradual commissioning of the system. Subsequent extensions have no effect on stations that are already in operation.

A transmission speed of between 9.6 kbit/s and 12 Mbit/s can be selected. This is selected as a standard value for all devices on the bus during system commissioning.

Basic features

Network topology	Linear bus, active bus terminator at both ends, branching only permitted with baud rates of <1.5 Mbit/s
Medium	Shielded, twisted cable
Number of stations	32 stations in each segment without repeaters. With repeaters, can be extended to 126 (maximum of 9 repeaters permitted)
Connectors	Preferably 9-pin D-Sub connectors

Structure

All devices must be connected in a line structure. Up to 32 nodes (masters or slaves) may be interconnected within this kind of segment. If there are more than 32 nodes, repeaters must be used (to increase the number of devices, for example).

Cable length

The maximum cable length depends on the transmission speed. The cable length specified can be increased by using repeaters. It is recommended that you do not connect more than 3 repeaters in series.

Baud rate (kbit/s)	9.6	19.2	93.75	187.5	500	1500	12000
Range/segment	1200 m	1200 m	1200 m	1000 m	400 m	200 m	100 m

Range in relation to transmission speed.

Bus terminator

At the beginning and end of each segment, the bus is terminated by terminators. To enable fault-free operation, you must ensure that the two bus terminators are constantly supplied with power. The terminators are located in the Profibus connectors and can be activated by moving the slide switch to ON.

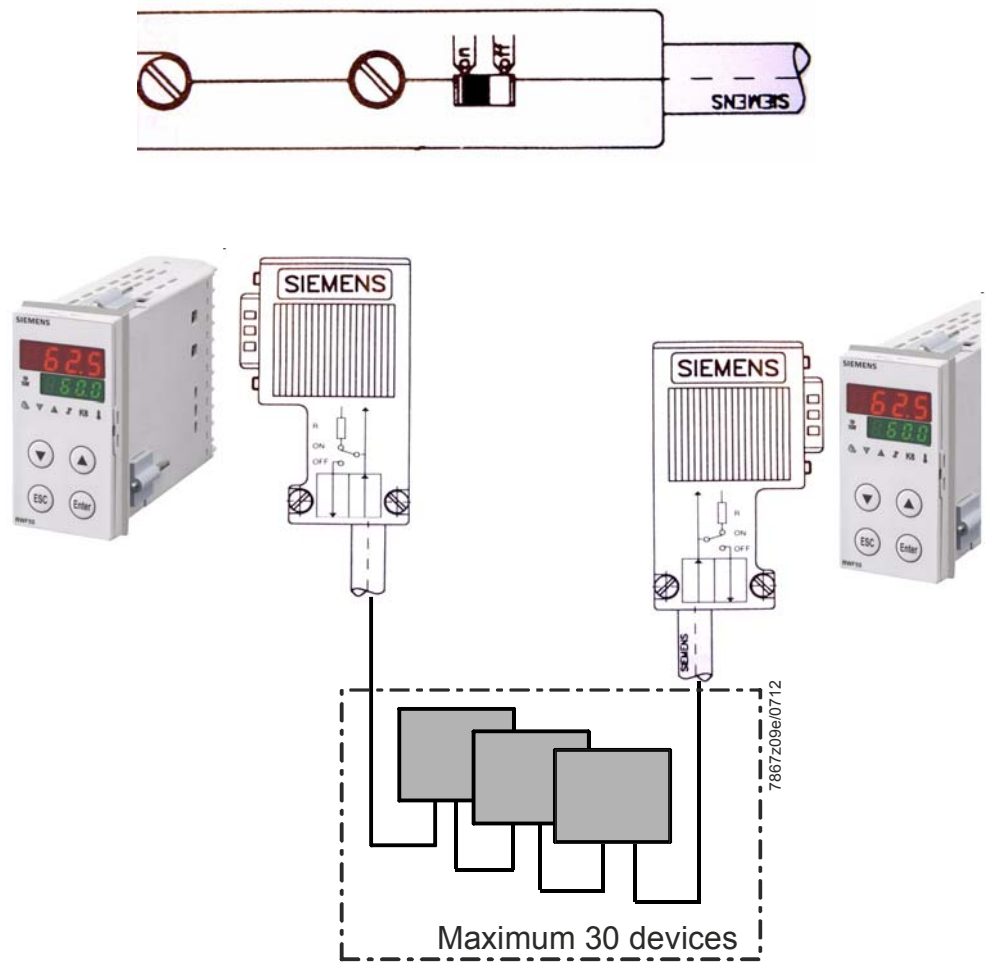

Figure 38: Bus terminator

Cable data

The cable length specifications relate to cable type A described below:

Surge impedance	135...165 Ω
Capacitance per unit length	<30 pf/m
Loop resistance	110 Ω /km
Cross-sectional area	>0.34 mm ²

Preferably, a 9-pin D-Sub connector should be used for Profibus networks with RS-485 transmission technology. The pin assignments on the connector and the wiring specifications are listed at the end of this chapter.

Several manufacturers offer Profibus DP cables and connectors. Please consult the Profibus product catalog (www.profibus.com) for designations and reference addresses.



Attention!

When connecting the devices, make sure you do not mix up the data lines. You must use shielded data lines. The braided shield and the foil shield underneath it (where applicable) should be connected at both sides and with a good conductive connection to protective ground.

Additionally, where possible you must ensure that data lines are laid separately from all power cables.

As an example of an appropriate cable, we recommend the following from Siemens:

Simatic Net Profibus 6XV1

Order no.: 830-0AH10

* (UL) CMX 75 °C (Shielded) AWG 22 *

Data rate

With data rates of ≥ 1.5 Mbit/s, branching must be avoided during installation.



Note!

For additional installation information, please refer to the Profibus DP installation guidelines (order no. 2.111) from the PNO.

Address:

Profibus Nutzorganisation e.V.

Haid- und Neu-Straße 7

76131 Karlsruhe

Internet: www.profibus.com

Recommendation:

Please observe the installation information provided by the PNO, especially in cases where variable speed drives are being used simultaneously.

Wiring and bus termination

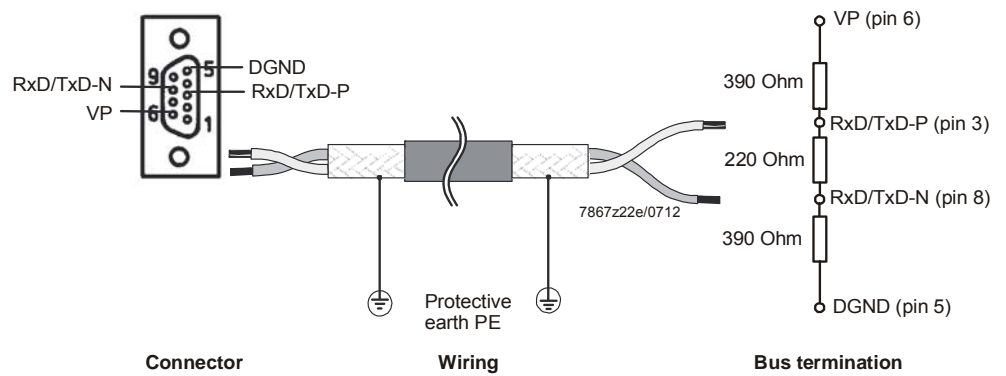

Figure 39: Wiring and bus termination

Profibus DP is designed for fast data exchange at field level. In this case, the central control devices (such as the PLC/PC) communicate with distributed field devices (such as I/Os, screen recorders, and controllers) via a fast serial connection. Data exchange with these distributed devices is usually cyclical.

The communication functions required for this are defined by basic Profibus DP functions in accordance with IEC 61158 and IEC 61784.

Basic functions

The central control device (master) reads input messages from the slaves cyclically and writes output messages to the slaves cyclically. The bus cycle time must be shorter than the program cycle time of the central PLC. As well as cyclical user data transfer, Profibus DP is able to carry out high-performance diagnostics and commissioning functions.

Technology transfer

- RS-485 twisted 2-wire line
- Baud rate of 9.6 kbit/s upto 12 Mbit/s

Bus access

- Master and slave devices, maximum 126 nodes on a bus (with repeater)

Communication

- Point-to-point (user data traffic)
- Cyclical master-slave user data traffic

Operation states

- Operate Cyclical transfer of input and output data
- Clear Inputs are read; outputs remain in a safe state
- Stop Only master-master data transfer is possible

Synchronization

- Sync-Mode Not supported by the RWF55
- Freeze-Mode Not supported by the RWF55

Functionality

- Cyclical user data transfer between DP master and DP slave(s)
- Dynamic activation or deactivation of individual DP slaves
- Checking of DP slave configuration
- Address assignment for DP slaves via the bus
- Configuration of DP master via the bus
- Maximum 246 bytes of input/output data possible per DP slave

Protection functions

- Threshold monitoring for DP slaves
- Access protection for inputs/outputs of DP slaves
- Monitoring of user data traffic with adjustable monitoring timer for DP master

Device types

- DP master class 2, e.g., programming/configuration devices
- DP master class 1, e.g., central automation devices such as PLC, PC, etc.
- DP slave, e.g., devices with binary or analog inputs/outputs, controllers, recorders, etc.

Cyclical data traffic

Data traffic between the DP master and DP slaves is automatically processed by the DP master in a fixed, constantly recurring order. The user specifies the assignment of a DP slave to a DP master during bus system configuration. The DP slaves to be included in or excluded from cyclical user data traffic are also defined.

The data traffic between the DP master and DP slaves is divided into parameter setting, configuration, and data transfer phases. Before a DP slave is included in the data transfer phase, the DP master checks (in the parameter setting and configuration phase) whether the desired configuration that has been configured matches the actual device configuration.

As part of this check, the device type, format information, and length information as well as the number of inputs and outputs must match. As a result of this, the user is provided with reliable protection against parameter setting errors. As an addition to the user data transfer function that the DP master performs automatically, it is also possible to send new parameter setting data to the DP slaves if requested by the user.

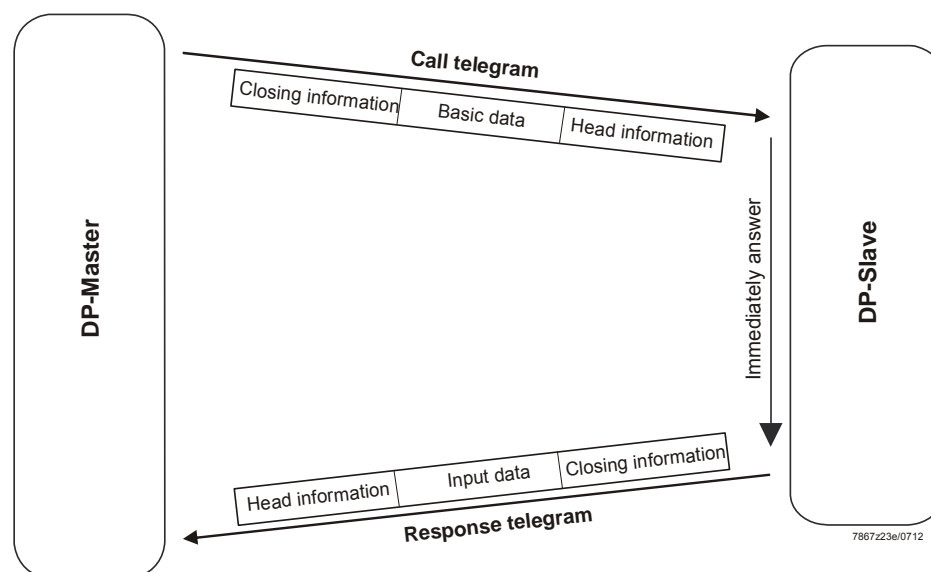
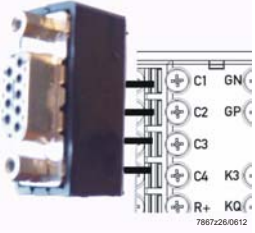

Figure 40: User data transfer with Profibus DP

12.2 Wiring

Assignment of 9-pole D-SUB jack

COM2 D-SUB jack		Pin: Signal on the device terminal strip 1	Description
6		C1: VP	Power supply - plus
3		C2: RxD/TxD-P	Received data/transmission data - plus
8		C3: RxD/TxD-N	Received data/transmission data - minus
5		C4: DGND	Ground

12.3 Parameter list

Signal reference	Access	Data type	Parameter
X1	RO	Float	Analog input I nP1
X2	RO	Float	Analog input I nP2
SP1	R/W	Float	Setpoint 1
SP2 (dSP)	R/W	Float	Setpoint 2
---	RO	Word	Outputs and states
---	RO	Word	Binary signal and Hardware character
Pb1	R/W	Float	Proportional range 1
dt	R/W	Float	Derivative action time
rt	R/W	Float	Integral action time
REM	RO	Word	Status remote operation
X3	RO	Float	Analog input I nP3
AL	R/W	Word	Limit value alarm
B1	RO	Float	Burner alarm
WR	RO	Float	Actual setpoint



Note!

The respective address ranges are given in the *.gsd file

13 What to do if ...

13.1 Alarm messages:

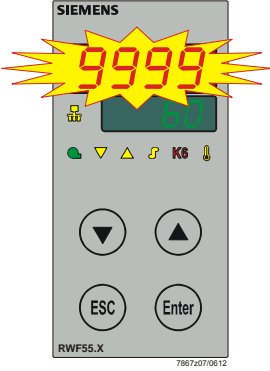
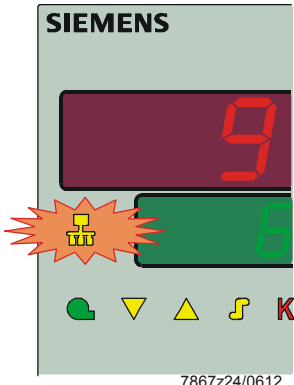
Display	Cause	Remedy
<p>9999 flashing</p> 	<p>Measured value exceeded limit The measured value is too great, lies outside the measuring range, or the sensor is faulty (9999 flashing).</p> <hr/> <p>Measured value dropped below limit The measured value is too small, lies outside the measuring range, or the sensor has a short-circuit (-1999 flashing).</p>	<p>* Check to see if sensor and connecting line are damaged or have a short-circuit</p> <p>⇒ Reference! See chapter 4.3 <i>Assignment of pins</i></p> <p>* Check to see if the correct sensor is selected or connected</p> <p>⇒ Reference! See chapter 14.1.1 <i>Analog input I nP1 (actual value)</i></p>
<p>The yellow communication symbol (top left) flashes</p> 	<p>Interface communication via Profibus, Modbus or PC software ACS411 (USB) is active</p>	<p>No remedy required, normal RWF55 behavior.</p>

13.2 Others

Display	Cause	Remedy
<p>On the upper display, the decimal place to the right is lit</p> 	<p>USB connection</p>	<p>Remove USB connection</p> <p>⇒ Reference! See chapter 10 <i>PC software ACS411</i></p>

14 Technical data

14.1 Inputs

14.1.1 Analog input InP1 (actual value)

For resistance thermometers, thermal elements or standard signals with 2nd order digital filters (configurable).

Sampling time	250 ms
---------------	--------

Resistance thermometers

Type	Measuring range	Measuring accuracy ^a	Impact of ambient temperature
Pt100; DIN EN 60751	-200...850 °C (-328...1562 °F)	≤0,05%	50 ppm/K
Pt1000; DIN EN 60751	-200...850 °C (-328...1562 °F)	≤0,05%	50 ppm/K
LG-Ni1000	-50...+160 °C (-58...320 °F)	≤0,05%	50 ppm/K
0...135 Ω		≤0,05%	50 ppm/K

^a Accuracies relate to the maximum measuring range.

Line resistance	Max. 30 Ω per line with 3-wire circuit
Line balancing	Not required with 3-wire circuits. With 2-wire circuits, line balancing can be performed by making an actual value correction

Thermal elements

Type	Measuring range	Measuring accuracy ^a	Impact of ambient temperature
Fe-CuNi J DIN EN 60584	-200...+1200 °C (-328...+2192 °F)	≤0.25%	≤100 ppm/K
NiCr-Ni K DIN EN 60584	-200...+1372 °C (-328...+2502 °F)	≤0.25%	≤100 ppm/K
Cu-CuNi T DIN EN 60584	-200...+400 °C (-328...+752 °F)	≤0.25%	≤100 ppm/K
NiCrSi-NiSi N DIN EN 60584	-100...+1300 °C (-148...+2372 °F)	≤0.25%	≤100 ppm/K
Pt-RhPt S DIN EN 60584	-50...+1768 °C (-58...+3214 °F)	≤0.25%	≤100 ppm/K
Pt-RhPt R DIN EN 60584	-50...+1768 °C (-58...+3214 °F)	≤0.25%	≤100 ppm/K
Pt-RhPt B DIN EN 60584	0...1820 °C (32...3308 °F)	≤0.25%	≤100 ppm/K

^a Accuracies relate to the maximum measuring range.

Cold-function temperature	Internal
---------------------------	----------

Standard signals

Measuring range	Measuring accuracy ^a	Impact of ambient temperature
Voltage DC 0...5 V Input resistance RE >2 MΩ	≤0.2%	200 ppm/K
Voltage DC 0...10 V Input resistance RE >2 MΩ	≤0.1%	100 ppm/K
Voltage DC 1...5 V Input resistance RE >2 MΩ	≤0.2%	200 ppm/K
Current 0...20 mA Voltage drop ≤2 V	≤0.1%	100 ppm/K
Current 4...20 mA Voltage drop ≤2 V	≤0.1%	100 ppm/K

^a Accuracies relate to the maximum measuring range.

14.1.2 Analog input InP2 (external setpoint, setpoint shifting)

Resistance measurement 0...1 kΩ or standard signals without linearization.

	Sampling time	750 ms
Resistance thermometer	Resistance (2-wire circuit)	0...1 kΩ linear ≤0.05% 50 ppm/K

Standard signals

Measuring range	Measuring accuracy ^a	Impact of ambient temperature
Voltage DC 0...5 V Input resistance RE >2 MΩ	≤0.2%	200 ppm/K
Voltage DC 0...10 V Input resistance RE >2 MΩ	≤0.1%	100 ppm/K
Voltage DC 1...5 V Input resistance RE >2 MΩ	≤0.2%	200 ppm/K
Current 0...20 mA Voltage drop ≤2 V	≤0.1%	100 ppm/K
Current 4...20 mA Voltage drop ≤2 V	≤0.1%	100 ppm/K

^a Accuracies relate to the maximum measuring range.

14.1.3 Analog input InP3 (outside temperature)

For resistance thermometers in 2-wire circuit, with fixed filter time constant.

	Sampling time	6 s		
Resistance thermometer	Type	Measuring range	Measuring accuracy ^a	Impact of ambient temperature
	Pt1000 DIN EN 60751	-200...+850 °C (-328...+1562 °F)	≤0.05%	50 ppm/K
	LG-Ni1000	-50...+160 °C (-58...+320 °F)	≤0.05%	50 ppm/K

^a Accuracies relate to the maximum measuring range.

14.1.4 Binary input D1

Potentialfree contact for the following functions, depending on the configuration:

- No function
- Setpoint shifting
- Setpoint changeover
- Alarm input

14.1.5 Binary input D2

Potentialfree contact for operating mode changeover:

Burner modulating, if contacts D2 and DG are open	LED for <i>operating mode 2-stage</i> , does not light up on the front
Burner 2-stage, if contacts D2 and DG are closed	LED for <i>operating mode, 2-stage</i> , lights up on the front

14.2 Monitoring the measuring circuit

In the event of error, the outputs assume defined states (configurable).

Measuring transducer	Measured value crossed limit	Sensor/line has short-circuit	Sensor/line interrupted
Resistance thermometer	●	●	●
Thermal elements	●	---	●
Voltage			
DC 1...5 V	●	●	●
DC 0...5 V	(●)	---	---
DC 0...10 V	(●)	---	---
Current			
DC 4...20 mA	●	●	●
DC 0...20 mA	(●)	---	---

● = detected

(●) = detected only if measuring range is exceeded

--- = not detected

⇒ Reference!
See chapter 13.1 *Alarm messages*.

14.3 Controller outputs OutP

Galvanic separation between supply voltage and analog inputs.

⇒ Reference!
See chapter 4.2 *Galvanic separation*

Relay K1 (NO contact) 1P, 1N (burner release)	
Contact rating	Max. 2 A at AC 240 V at $\cos\phi > 0.6$
Contact life	250,000 switching cycles at high-fire
Contact protection	Varistor
Power supply for transducer G+, G-	DC 24 V $\pm 10\%$ /max. 30 mA, short-circuit-proof

The following relay data are those specified by the supplier.

Relay K2, KQ (controlling element OPEN)	
Contact rating	Max. 2 A at AC 240 V and $\cos\phi > 0.6$
Contact life	200,000 switching cycles at high-fire
Contact protection	RC combination
Relay K3, KQ (controlling element CLOSE)	
Contact rating	Max. 2 A at AC 240 V at $\cos\phi > 0.6$
Contact life	200,000 switching cycles at high-fire
Contact protection	RC combination
Relay K6 (NO contact), 6P, 6N (multifunctional relay)	
Contact rating	Max. 2 A at AC 240 V at $\cos\phi > 0.6$
Contact life	200,000 switching cycles at high-fire
Contact protection	Varistor

Relay data are those specified by the supplier.

Analog output A+, A-	
Voltage	DC 0...10 V short-circuit-proof
Load resistance	$R_{Last} \geq 500 \Omega$
Accuracy	$\leq 0.25\%$, ± 50 ppm/K
Current	0...20 mA/4...20 mA
Load resistance	$R_{Last} \leq 500 \Omega$
Accuracy	$\leq 0.25\%$, ± 50 ppm/K

Interface RS-485

Baudrate	4800 Baud 9600 Baud 19200 Baud 38400 Baud
Protocol	Modbus
Unit address	1...99

Profibus interface

Only present with RWF55.6!

14.4 Controller

Type of controller	3-position controller and continuous controller
Controller structure	P/PI/PD/PID
Sampling time	250 ms

14.5 Electrical data

Power supply (switching network section)	AC 110...240 V +10/-15% 48...63 Hz
Electrical safety	To DIN EN 60730, part 1 Overvoltage category III Degree of contamination 2
Safety class I	With internal separation from SELV electrical circuits
SELV voltage	Max. 30 V
Power consumption	Max. 20 VA
Data backup	EEPROM
Electrical connection	At the rear via screw terminals
- Cross-sectional area	0.25...1.5 mm ² fine-wired
- Stranded wire with	- Ferrules to DIN 46228 - Pin-type cable socket to DIN 46231 - Crimp-type cable socket in fork-form for M3 thread (dimensions to DIN 46237)
With UL applications	Use of the cable lug or ferrules to UL486A-B (UL listed or recognized)
Tightening torque	0.5 Nm
Electromagnetic compatibility	DIN EN 61326-1
Emitted interference	Class B
Immunity	Meeting industrial requirements

14.6 Housing

Type of housing	Made of Makrolon for control panel mounting to DIN IEC 61554 (use in indoor)
Color	Light-grey RAL7035
Mounting depth	122 mm
Mounting position	Optional
Degree of protection	To DIN EN 60529 Front side IP66 Rear IP20
Weight	To UL50E and to NEMA 250 Front side type 5
- RWF55.5	(Fully equipped) Approx. 329 g
- RWF55.6	Approx. 342 g

14.7 Environmental conditions

Storage	DIN IEC 60721-3-1
Climatic conditions	Class 1K3
Mechanical conditions	Class 1M2
Temperature range	-40...70 °C
Humidity	<95% r.h.
Transport	DIN IEC 60721-3-2
Climatic conditions	Class 2K2
Mechanical conditions	Class 2M2
Temperature range	-40...70 °C
Humidity	<95% r.h.
Operation	DIN IEC 60721-3-3
Climatic conditions	Class 3K3
Mechanical conditions	Class 3M3
Temperature range	-20...50°C
Humidity	<95% r.h.
Installation altitude	Max. 2000 m above sea level



Attention!

Condensation, formation of ice and ingress of water are not permitted!

14.8 Segment display

Height of numerals	
- Upper display	10 mm
- Lower display	7 mm
Color	
- Upper display	Red
- Lower display	Green
Digits	4 (including 0, 1 or 2 decimal places, configurable)
Range of display	-1999...9999

14.9 Standards and certificates



Applied directives:

- Low-voltage directive 2014/35/EC
- Electromagnetic compatibility 2014/30/EC

Compliance with the regulations of the applied directives is verified by the adherence to the following standards / regulations:

- Temperature control devices and temperature limiters for heat generating systems DIN EN 14597
- Automatic electrical controls for household and similar use Part 1: General requirements DIN EN 60730-1
- Automatic electrical controls for household and similar use Part 2-9: Particular requirements for temperature sensing controls DIN EN 60730-2-9
- Electrical equipment for measurement, control and laboratory use - EMC requirements Part 1: General requirements DIN EN 61326-1

The relevant valid edition of the standards can be found in the declaration of conformity!



EAC Conformity mark (Eurasian Conformity mark)



ISO 9001:2008
ISO 14001:2004
OHSAS 18001:2007



China RoHS
Hazardous substances table:
<http://www.siemens.com/download?A6V10883536>

15 Key

A	Switch-on point for high-fire when response threshold (q) is reached
ACrA	Response by Out of Range
Adr	Device address Modbus
AF	Alarm function
AL	Limit value
At1	Outside temperature 1
At2	Outside temperature 2
B	Switch-off point for burner
bdrt	Baudrate
bi n1	Binary input 1
bi n2	Binary input 2
bi nF	Binary input
CACt	Operating action
Cntr	Controller
CodE	Level lockout
ConF	Configuration
CtYP	Controller type
db	Dead band
dECP	Decimal point
dF1	Filter time constant
dF2	Filter time constant
dF3	Filter time constant
dFt	Data format
di SL	Lower display
di SP	Display
di SU	Upper display
dSP	Setpoint
dt	Derivative action time
dt t	Remote Detection Timer
End	End value
FnC2	Function
FnC3	Function
FnCt	Function
Ht1	Boiler temperature 1
Ht2	Boiler temperature 2
HYS1	Switch-on threshold heating controller
HYS2	Switch-off threshold heating controller
HYS3	Switch-off threshold heating controller
HYS4	Switch-on threshold cooling controller
HYS5	Switch-off threshold cooling controller
HYS6	Switch-off threshold cooling controller
HYS t	Switching difference
I nP	Analog input
I nP1	Analog input 1 (actual value)
I nP2	Analog input 2 (external setpoint or setpoint shifting)
I nP3	Analog input 3 (outside temperature)
I ntF	Interface
OFF1	Correction of measured value
OFF2	Correction of measured value
OFF3	Correction of measured value
oLHi	Upper working range limit
oLLo	Lower working range limit
OPnt	Zero point
OPr	User
OutP	Control outputs

PArA	Parameter
Pb	Proportional range
Pb1	Proportional range 1
q	Response threshold
qeff	Sum of all integrals
rAFC	Thermal shock protection
rAL	Limit value
rASL	Ramp slope
rOut	Value when out of range
rt	Integral action time
SCH1	End of display
SCH2	End of display
SCL1	Start of display
SCL2	Start of display
SEn1	Sensor type
SEn2	Sensor type
SEn3	Sensor type
Si Gn	Signal type
SP1	Setpoint 1
SP2	Setpoint 2
SPH	Setpoint limitation end
SPL	Setpoint limitation start
t	Time
t1	Power ON (startup at actual value)
t2	Actual value of ramp stop outside tolerance band
t3	Actual value returned to tolerance band
t4	Setpoint reached, thermal shock protection (TSS) no longer active
toLP	Tolerance band of ramp
tout	Timeout
tt	Running time of controlling element
Uni t	Unit of temperature
W	Setpoint
Y	Angular positioning

16 List of figures

Figure 1: Block structure	12
Figure 2: Dimensions of RWF55.....	14
Figure 3: Mounting in a panel cutout.....	15
Figure 4: Test voltages	18
Figure 5: Assignment of terminals	19
Figure 6: Control sequence of heating controller	22
Figure 7: Control sequence of cooling controller	22
Figure 8: Control sequence of modulating burner, 3-position output	23
Figure 9: Control sequence of modulating burner, analog output.....	24
Figure 10: Control sequence of 2-stage burner, 3-position output.....	25
Figure 11: Control sequence of 2-stage burner, analog output	26
Figure 12: Setpoint changeover or setpoint shift	29
Figure 13: Setpoint changeover SP1 / external setpoint	30
Figure 14: Setpoint shifting analog / binary.....	31
Figure 15: External setpoint, setpoint shifting binary via dSP	32
Figure 16: Heating curve slope	33
Figure 17: Control sequence response threshold (q).....	34
Figure 18: Control sequence <i>Cold start of plant</i>	35
Figure 19: Thermal shock protection (TSS).....	37
Figure 20: Meaning of display and buttons	38
Figure 21: Display start	40
Figure 22: Basic display.....	40
Figure 23: Display of self-setting function	44
Figure 24: Display of software version	45
Figure 25: Display segment test	45
Figure 26: Parameterization.....	46
Figure 27: Configure	49
Figure 28: Alarm function lk1...lk6.....	56
Figure 29: Alarm function lk7 and lk8.....	56
Figure 30: Self-setting function in high-fire operation	62
Figure 31: Great difference between actual value and setpoint.....	63
Figure 32: Small control deviation.....	63
Figure 33: Pb too small	64
Figure 34: Pb too large	64
Figure 35: rt, dt too small.....	64

Figure 36: rt, dt too large.....	64
Figure 37: Optimum adjustment	64
Figure 38: Bus terminator	73
Figure 39: Wiring and bus termination.....	75
Figure 40: User data transfer with Profibus DP	76
Figure 41: COM2 D-SUB jack.....	77

Index

A		
ACS411		
Changing the parameters	65	
Installation	67	
Languages	66	
License and liability regulations	66	
Others	67	
PC software ACS411	65	
Place of installation	66	
Prerequisites for hardware	66	
Procurement of PC software ACS411	66	
Safety notes	65	
Setting the correct system parameters	65	
Alarm function AF		
Limit value AL relative to setpoint	56	
C		
Changing setpoint		
SP2	41	
Changing the setpoint		
SP1	41	
Configuration		
Alarm function AF	56	
Analog input InP1	50	
Analog input InP2	52	
Analog input InP3	53	
Analog output	58	
Binary functions bi nF	59	
Binary output	58	
Control outputs OutP	58	
Controller Cntr	54	
Display di SP	60	
Interface IntF	61	
Thermal shock protection (TSS) rAFC	55	
Configuration ConF	49	
D		
Description		
Interface	11	
Option	11	
E		
Electrical connection		
Connection of external components	17	
Electrical connections	17	
Assignment of terminals	19	
Fusing	17	
Galvanic separation	18	
Incorrect use	17	
Installation notes	17	
Safety regulations	17	
Screw terminals	17	
Suppression of interference	17	
I		
Identification of product no.	13	
Location	13	
Product nos.	13	
Scope of delivery	13	
Type field	13	
Installation	14	
Cleaning the front	16	
Dimensions	14	
Installation site and climatic conditions	14	
Mounting the controller in a panel cutout	15	
Removing the controller from the panel cutout	16	
Side-by-side mounting	15	
Introduction	8	
Block structure	12	
Control	11	
Cooling controller	11	
Correct use	9	
Description	11	
General notes	8	
Mounting	11	
Notification symbols	10	
Presentation	10	
Qualified personnel	9	
Safety notes	9	
Typographical conventions	9	
Use in heating plants	11	
Warning symbols	9	
K		
Key	88	
M		
Modbus interface	68	
Configuration level	70	
Device data	71	
Device state	71	
Parameter level	69	
Remote operation	70	
User level	68	
O		
Operating mode		
Output	24	
Operating modes	22	
2-stage burner, 3-position output	25	
2-stage burner, analog output	26	
Burner shutdown	27	
Cold start of plant	35	
Cooling controller	22, 24, 26, 34, 36	
External setpoint, setpoint shifting binary via dSP	32	
Heating controller	22, 35	
Heating curve	33	
High-fire operation	23	
Interlocking	35, 37	
Low-fire operation	22	
Modulating burner, 3-position output	23	

Modulating burner, analog output	24	Wiring	77
Operating mode changeover	23	R	
Predefined setpoint	28	RS-485 Technology transfer	
Response threshold (q)	34	Basic features	72
Setpoint changeover SP1 / external setpoint via InP2	30	Basic functions	75
Setpoint changeover SP1 / SP2 or setpoint shift analog via InP2	29	Bus terminator	73
Setpoint shifting SP1 analog via InP2 / binary via dSP	31	Cable data	74
Thermal shock protection	37	Cable length	72
Thermostat function	22	Cyclical data traffic	76
Weather-compensated setpoint shifting	33	Data rate	74
Operation	38	Structure	72
3-position controller	42	Wiring and bus termination	75
Basic display	40	S	
Basic display	38	Self-setting function	62
Cancel	44	2 procedures	63
Changing the setpoints	41	Checking the controller parameters	64
Display of software version	45	Conditions	63
Flashing actual value display	39	Self-setting function in high-fire operation	62
Initialization	38	T	
Manual control	39	Technical data	79
Manual control, 2-stage burner	43	Binary input D2	82
Manual control, modulating burner	42	Controller	85
Meaning of display and buttons	38	Controller outputs OutP	84
Modulating controller	42	Electrical data	85
Parameter display	38	Environmental conditions	86
Segment test	45	Housing	85
Self-setting function	38	Inputs	79
Start	44	Monitoring the measuring circuit	83
Starting the self-setting function	44	Resistance thermometers	79
Timeout	41	Segment display	86
User level	41	Standard signals	80
P		Standards and certificates	87
Parameterization		Technical Data	
Display of controller parameters	47	Analog input InP1	79
Parameterization PArA	46	Analog input InP2	81
PC software ACS411		Analog input InP3	81
Measuring accuracy	67	Binary input D1	81
Operating systems	66	Interface RS-485	84
Powering the controller via the USB port	67	Profibus interface	84
Use of USB port	67	Resistance thermometer	81
Using the HUB	67	Standard signals	81
PC-Software ACS411		Thermal elements	79
Switching off	67	W	
Profibus-DP interface	72	What to do if...	78
Parameter list	77	Alarm messages	78
RS-485 Technology transfer	72	Others	78
		Wiring	
		Assignment of 9-pole D-Sub jack	77

Siemens AG Infrastructure & Cities Sector Building Technologies Division
Berliner Ring 23
D-76437 Rastatt
Tel. +49 7222 598 279
Fax +49 7222 598 269
www.siemens.com

© 2017 Siemens AG Infrastructure & Cities Sector
Building Technologies Division
Subject to change!